

## Features

- 85~305Vac input with PFC (277Vac available)
- 40mm ultra slim width
- High efficiency up to 95% and low power dissipation <3W
- Built-in MODBus protocol
- 200% peak power capability
- 600% pulse current capability @15ms
- Built-in constant current limiting circuit
- Current sharing up to 960W (3+1) for parallel use
- Protections: Short circuit / Overload / Over voltage / Over temperature
- Fanless design, cooling by free air convection
- Over voltage category III (OVC III)
- -40~+85°C wide range operation temperature (>+60°C derating)
- Operating altitude up to 5000 meters
- Built-in DC OK relay contact and remote ON/OFF control
- Ultra low inrush current <10A
- Built-in OR-ing FET
- Tool free terminal block (LA Type)
- Conformal coating
- Can be installed on DIN rail TS-35/75 or 15
- 5 years warranty

## Applications

- Industrial control system
- Semiconductor fabrication equipment
- Factory automation
- Electro-mechanical apparatus

## GTIN CODE



MW Search: <https://www.meanwell.com/serviceGTIN.aspx>

## Description

The XDR-240 series is a 240W AC/DC high-end ultra slim industrial DIN rail power. Key features of this series include a narrow 40mm casing, optimizing system installation space, and an ultra-wide input range of 85~305Vac suitable for global use. It boasts a maximum efficiency of 95% and a low standby power consumption of <3W for energy savings and carbon reduction. It supports MODBus communication interface, provides constant current with up to 200% peak power, and can handle instantaneous peak current of 600%. It has a fanless design, ultra-wide operating temperature range of -40 to +85°C (up to +60°C at full load); OVCIII compliance; parallel function capability up to 960W; ultra-low inrush current of <10A, and includes DC OK and remote ON/OFF functions. It also has a built-in OR-ing FET, the internal PCB has a coating for basic moisture and dust protection, and it has multiple terminal blocks for selection. With comprehensive protection functions, complete safety certifications, and a 5-year warranty, the XDR-240 series is a compact, high-performance, and highly reliable DIN rail power supply.

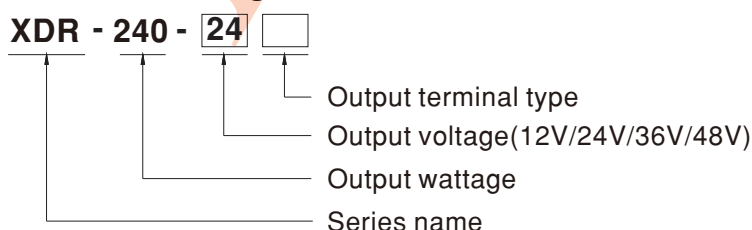
## Model Encoding



Terminal Type Options		Note
Blank	Screw Terminal 	In stock
LA	Lever Actuated 	In stock
PI	Push In 	In stock

## SPECIFICATION

MODEL		XDR-240-12□	XDR-240-24□	XDR-240-36□	XDR-240-48□	
		□ =Blank, LA, PI				
OUTPUT	DC VOLTAGE	12V	24V	36V	48V	
	LOAD CURRENT RANGE	0 ~ 20A	0 ~ 10A	0 ~ 6.66A	0 ~ 5A	
	RATED POWER	240W				
	PEAK	CURRENT (5sec.)	40A	20A	13.33A	10A
		POWER (5sec.)	480W(5 sec.)			
	RIPPLE & NOISE (max.) Note.2	100mVp-p	100mVp-p	120mVp-p	150mVp-p	
	VOLTAGE ADJ. RANGE	12 ~ 15V	24 ~ 29V	36 ~ 42V	48 ~ 55V	
	VOLTAGE TOLERANCE Note.3	±1.0%	±1.0%	±1.0%	±1.0%	
	LINE REGULATION	±0.5%	±0.5%	±0.5%	±0.5%	
	LOAD REGULATION	±1.0%	±1.0%	±1.0%	±1.0%	
SETUP, RISE TIME	1500ms, 150ms/230Vac    3000ms, 150ms/115Vac at full load					
HOLD UP TIME (Typ.)	20ms/230VAC    20ms/115VAC at full load					
INPUT	AC VOLTAGE RANGE	85 ~ 305Vac				
	DC VOLTAGE RANGE	80 ~ 431Vdc (Derating 50% Load @80Vdc)				
	NO LOAD POWER CONSUMPTION	3W @115Vac & 230Vac				
	FREQUENCY RANGE	47 ~ 63Hz				
	POWER FACTOR (Typ.)	PF>0.95/230Vac    PF>0.98/115Vac at full load				
	EFFICIENCY (Typ.)	94%	94.5%	94.5%	95%	
	AC CURRENT (Typ.)	2.6A/115Vac    1.3A/230Vac				
	INRUSH CURRENT (Typ.)	COLD START    6A/115Vac    10A/230Vac				
LEAKAGE CURRENT	<1mA / 240Vac					
PROTECTION	OVERLOAD	Normally works within 110 ~ 200% rated output power for more than 5 seconds and then constant current limiting without shutdown, (Vout>30%), recovers automatically after fault condition is removed >200% rated power, constant current limiting with auto-recovery after fault condition is removed				
	OVER VOLTAGE	15 ~ 18V	30 ~ 34V	43 ~ 50V	56 ~ 65V	
	OVER TEMPERATURE	Protection type : Shut down o/p voltage, auto-recovery after fault condition is removed Protection type : Shut down o/p voltage, recovers automatically after temperature goes down				
FUNCTION	PARALLEL	Up to 960W (3+1) units; Please refer to the Instruction manual.				
	DC OK	Relay Contact Ratings (max.):30Vdc/1A, 30Vac/0.5A resistive load				
	REMOTE CONTROL	Power ON : Short; Power OFF: Open. Please refer to the Instruction manual.				
	MODBUS INTERFACE	Communication provides functions such as control, setting, and monitoring.				
	PULSE CURRENT CAPABILITY	6 times rated current for 15ms				
ENVIRONMENT	WORKING TEMP.	-40 ~ +85°C (Refer to "Derating Curve")				
	WORKING HUMIDITY	20 ~ 95% RH non-condensing				
	STORAGE TEMP., HUMIDITY	-40 ~ +85°C, 10 ~ 95% RH non-condensing				
	TEMP. COEFFICIENT	±0.03%/°C (0 ~ 60°C) on Load output				
	VIBRATION	Component:10 ~ 500Hz, 2G 10min./1cycle, 60min. each along X, Y, Z axes; Mounting: Compliance to IEC60068-2-6				
	OPERATING ALTITUDE Note.4	5000 meters / OVC II				
	OVER VOLTAGE CATEGORY	III; altitude up to 2000 meters				
SAFETY & EMC (Note.6)	SAFETY STANDARDS	CSA Class I, DIV2 Group A, B, C, D Hazardous Locations T4; UL61010; DEKRA BS EN/EN62368-1, BS EN/EN61558-1/-2-16, BS EN/EN61010; CB IEC62368-1, IEC61558-1, IEC61010; RCM AS/NZS 62368-1, AS/NZS 61558-1/-2-16; BIS IS13252 (Part 1):2010; KC KC62368-1; BSMI CNS15598-1; CCC GB4943.1; EAC TPTC004 approved				
	WITHSTAND VOLTAGE	I/P-O/P: 4KVac    I/P-FG: 2KVac    O/P-FG: 1.5KVac    O/P-DC OK: 0.5KVac				
	ISOLATION RESISTANCE	I/P-O/P, I/P-FG, O/P-FG: 100M Ohms/500VDC/25°C/ 70%RH				
	EMC EMISSION	Parameter	Standard	Test Level / Note		
		Conducted	BS EN/EN55032 (CISPR32)	Class B		
		Radiated	BS EN/EN55032 (CISPR32)	Class B		
		Harmonic Current	BS EN/EN61000-3-2	Class A		
	EMC IMMUNITY	Voltage Flicker	BS EN/EN61000-3-2	-----		
		BS EN/EN55035, BS EN/EN61204-3, BS EN/EN61000-6-2(BS EN/EN50082-2)				
		Parameter	Standard	Test Level / Note		
ESD		BS EN/EN61000-4-2	Level 4, 15KV air ; Level 4, 8KV contact; criteria A			
Radiated		BS EN/EN61000-4-3	Level 3, 10V/m ; criteria A			
EFT / Burst		BS EN/EN61000-4-4	Level 4, 4KV ; criteria A			
Surge		BS EN/EN61000-4-5	Level 4, 2KV/Line-Line ; Level 4, 4KV/Line-Line-Chassis ; criteria A			
OTHERS	MTBF	K hrs min. Telcordia SR-332 (Bellcore);    K hrs min. MIL-HDBK-217F (25°C)				
	DIMENSION	40*125.2*116mm (W*H*D)				
	PACKING	Kg; pcs/ Kg / CUFT				
NOTE	<p>1. All parameters NOT specially mentioned are measured at 230Vac input, rated load and 25°C of ambient temperature.</p> <p>2. Ripple &amp; noise are measured at 20MHz of bandwidth by using a 12" twisted pair-wire terminated with a 0.1 μ F &amp; 47 μ F parallel capacitor.</p> <p>3. Tolerance : includes set up tolerance, line regulation and load regulation.</p> <p>4. The ambient temperature derating of 3.5°C/1000m with fanless models and of 5°C/1000m with fan models for operating altitude higher than 2000m(6500ft).</p> <p>5. Installation clearances : 40mm on top, 20mm on the bottom, 5mm on the left and right side are recommended when loaded permanently with full power. In case the adjacent device is a heat source, 15mm clearance is recommended.</p> <p>6. The power supply is considered a component which will be installed into a final equipment. The final equipment must be re-confirmed that it still meets EMC directives. (as available on <a href="https://www.meanwell.com/Upload/PDF/EMI_statement_en.pdf">https://www.meanwell.com/Upload/PDF/EMI_statement_en.pdf</a>)</p> <p>※ Product Liability Disclaimer : For detailed information, please refer to <a href="https://www.meanwell.com/serviceDisclaimer.aspx">https://www.meanwell.com/serviceDisclaimer.aspx</a></p>					

PFC fosc : 80KHz  
 PWM fosc : 65KHz

### Block Diagram

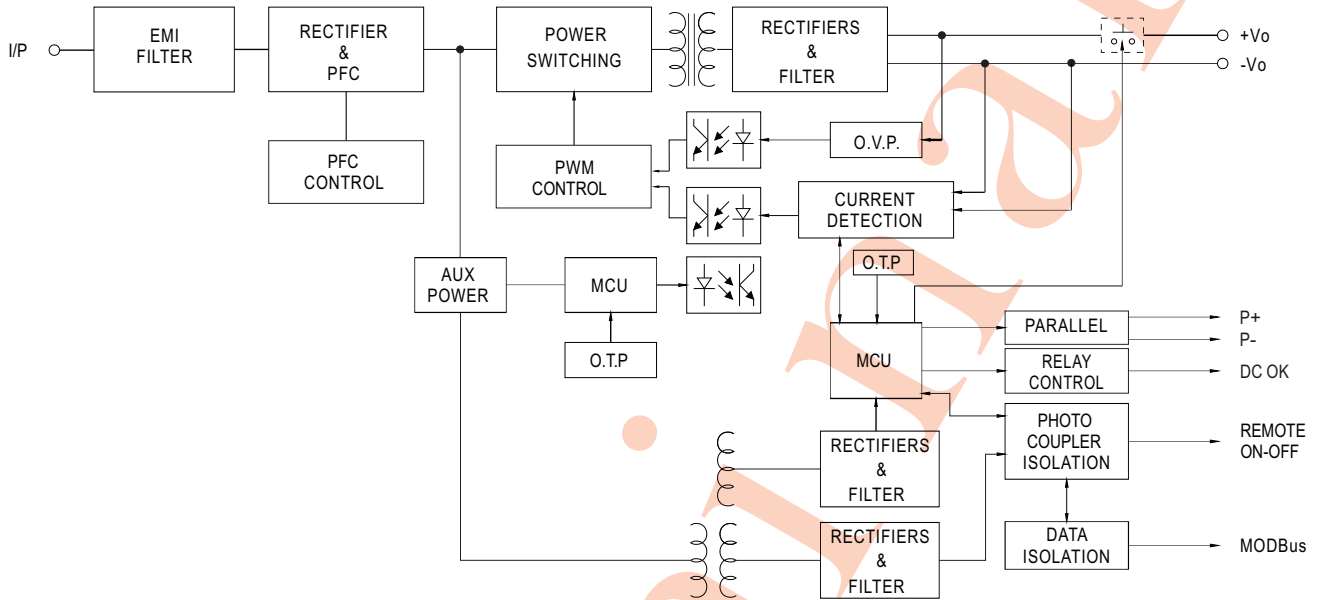

### Derating Curve

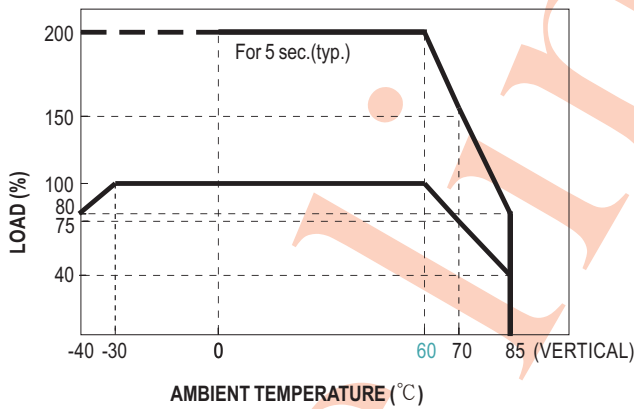

### Output derating VS input voltage

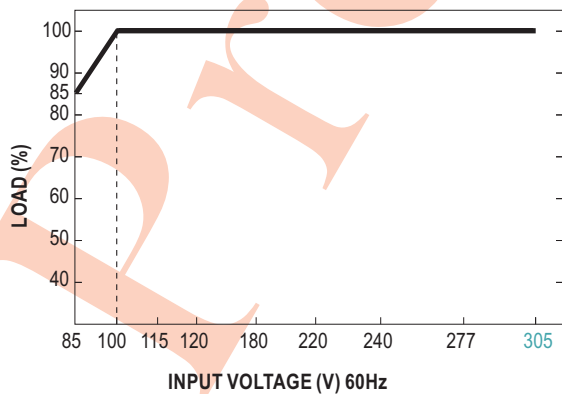

■ Peak Power ( $\leq 2 \cdot I_o$ )

$$P_{av} = \frac{P_{pk} \times t + P_{npk} \times (T-t)}{T} \leq P_{rated}$$

$$Duty = \frac{t}{T} \times 100\% \leq 35\%$$

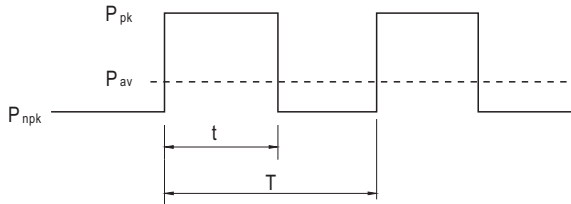

$P_{av}$  : Average output power (W)

$P_{pk}$  : Peak output power (W)

$P_{npk}$  : Non-peak output power (W)

$P_{rated}$  : Rated output power (W)

$t$  : Peak power width (sec)

$T$  : Period (sec)

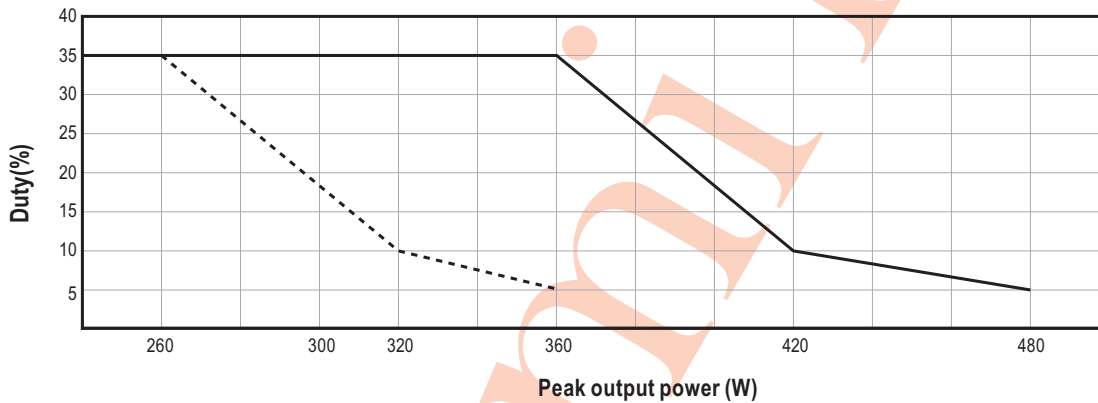
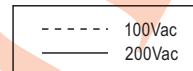

For example (24V model) :

$V_{in} = 200V$      $Duty\_max = 5\%$

$P_{av} = P_{rated} = 240W$

$P_{pk} = 480W$

$t \leq 5\text{ sec}$

$T \geq \frac{5\text{ sec}}{5\%} \geq 100\text{sec}$

$$P_{npk} \leq \frac{T P_{av} - t P_{pk}}{T-t}$$

$P_{npk} \leq 227.4W$

■ Peak Current Capability ( $> 2 \cdot I_o$ )

The device can deliver peak currents (up to several milliseconds) which are higher than the specified short term currents.

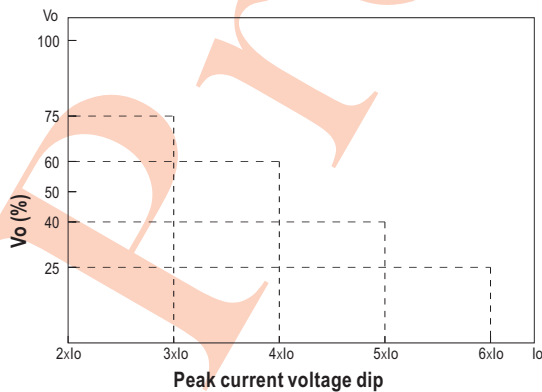

Load	Vo(%)	Time
3xIo	75	100ms
4xIo	60	70ms
5xIo	40	40ms
6xIo	25	15ms

## Function Manual

Pin No.	Function	Description
1	P+	Current sharing signal. When units are connected in parallel, the P+ pins of the units should be connected to allow current balance between units.
2	P-	This pin connects to the negative terminal(-Vo).
3,4	DC_OK	Power signals
5,7	GND_AUX	The signal return is isolated from the output terminal. (+Vo & -Vo)
6	MODBus_A	MODBus Output
8	MODBus_B	MODBus Input
9	Remote ON-OFF	Turns the output ON and OFF by electrical or dry contact between pin 10 (+5V AUX), Short: Power ON, Open: Power OFF.
10	+5V AUX	Remote control power signals.

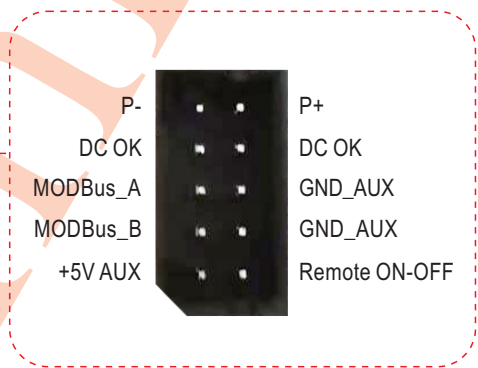
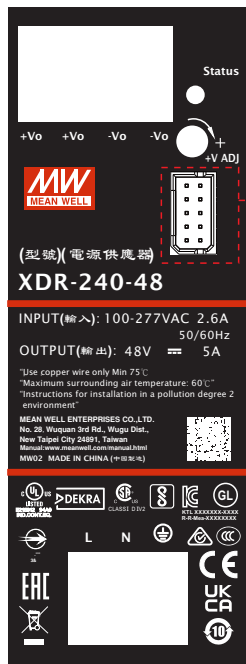

### 1.Parallel Use

XDR-240 has the built-in active current sharing function and can be connected in parallel, up to 4 units, to provide higher output power as exhibited below :

- ※ The power supplies should be paralleled using short and large diameter wiring and then connected to the load.
- ※ Difference of output voltages among parallel units should be less than 0.2V.
- ※ The total output current must not exceed the value determined by the following equation:  

$$\text{Maximum output current at parallel operation} = (\text{Rated current per unit}) \times (\text{Number of unit}) \times 0.9$$
- ※ When the total output current is less than 5% of the total rated current, or say (5% of Rated current per unit)  $\times$  (Number of unit) the current shared among units may not be fully balanced.

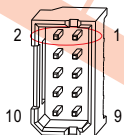

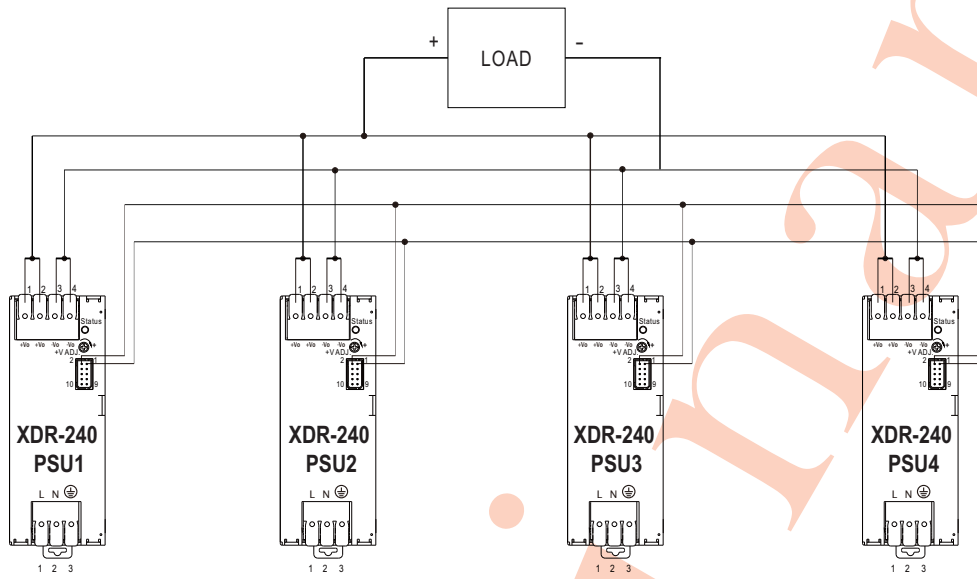

## 2. DC OK Relay Contact

Contact Close	PSU turns ON / DC OK.
Contact Open	PSU turns OFF / DC Fail.
Contact Ratings (max.)	30V/1A resistive load.

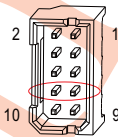

## 3. Support MODBus Communication

Communication provides functions such as control, setting, and monitoring. Parameters include output voltage, output power, input voltage, etc. For details, Please refer to: <http://www.meanwell.com/manual.html>

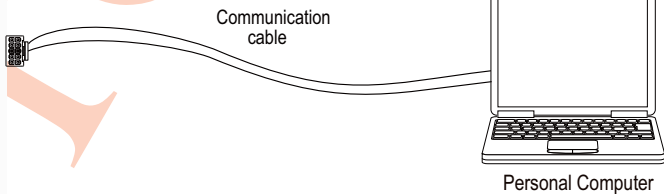
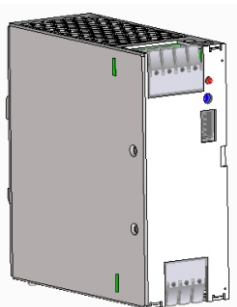
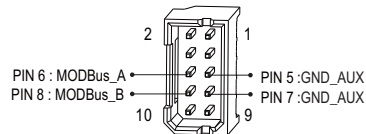

#### 4. Remote ON-OFF Control

The PSU can be turned ON/OFF by using the "Remote Control" function.

Connector Pin No.	Remote ON-OFF	DC Output Status
Pin9:10	Short	Power supply ON
Pin9:10	Open	Power supply OFF

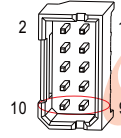

#### 5. Protection Against Inverse Voltages From The Load

Loads such as motors and sensors in deceleration can feed voltage back to the power supply.

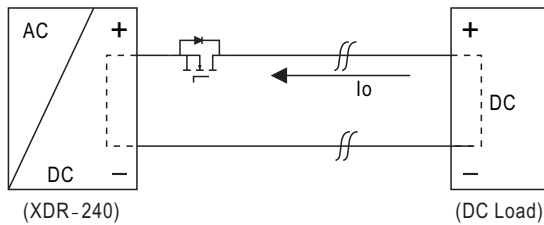

PSU'S Oring FET turn OFF voltage	
MODEL	Max. allowable Inverse Voltage
XDR-240-12	<16V
XDR-240-24	<35V
XDR-240-36	<50V
XDR-240-48	<63V

#### 6. LED alarm

Function	Description	Output of alarm
DC OK	DC Fail	OFF
	DC OK	Green
DC Fail	DC Fail	Red
	DC OK	OFF

## ■ Mechanical Specification

(Unit:mm , Tolerance  $\pm 1$ mm)

Case No. Unit:mm

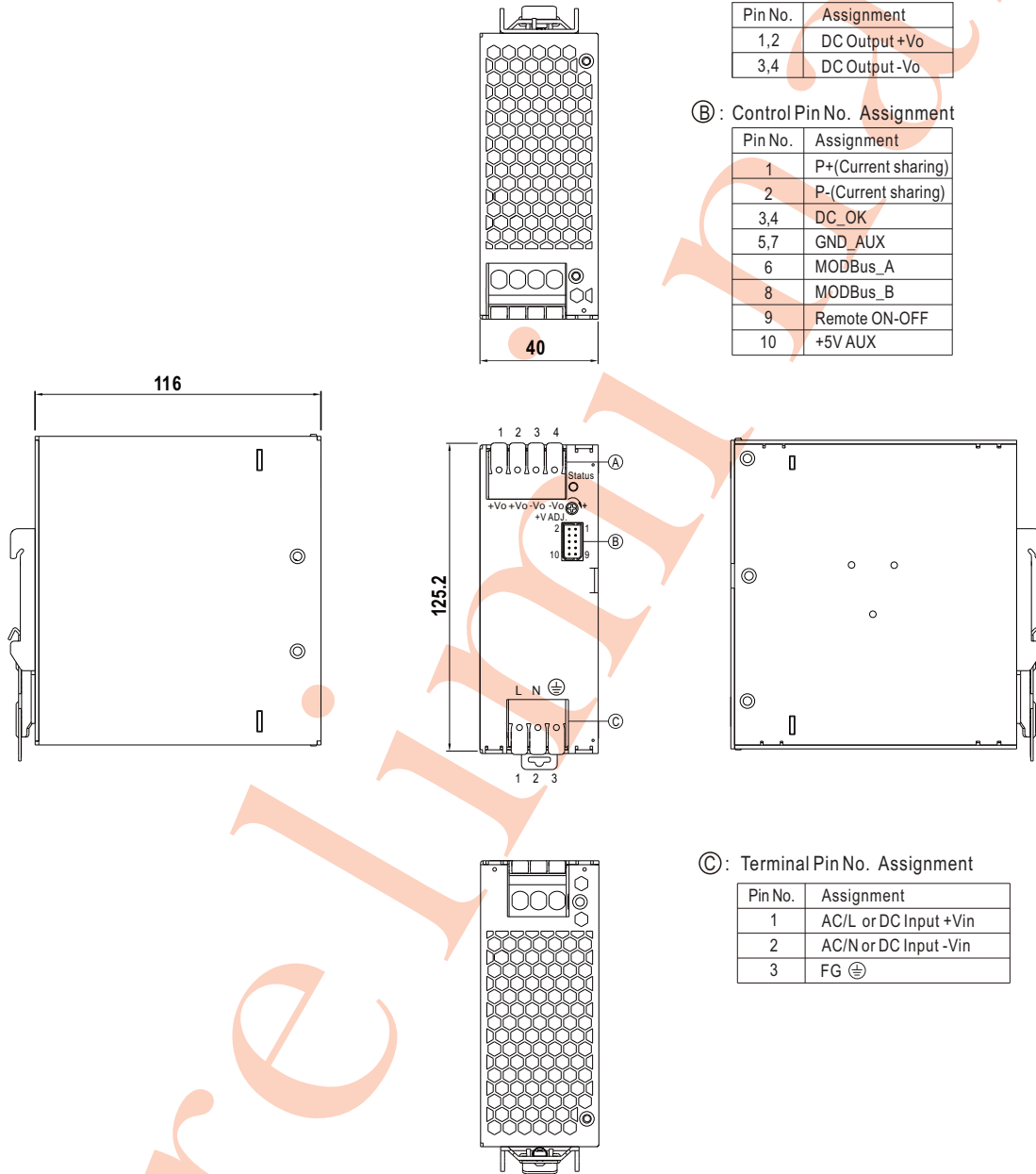

### Ⓐ: Terminal Pin No. Assignment

Pin No.	Assignment
1,2	DC Output +Vo
3,4	DC Output -Vo

### Ⓑ: Control Pin No. Assignment

Pin No.	Assignment
1	P+(Current sharing)
2	P-(Current sharing)
3,4	DC_OK
5,7	GND_AUX
6	MODBus_A
8	MODBus_B
9	Remote ON-OFF
10	+5V AUX

### Ⓒ: Terminal Pin No. Assignment

Pin No.	Assignment
1	AC/L or DC Input +Vin
2	AC/N or DC Input -Vin
3	FG $\oplus$

## ■ Recommend Wiring

	AC Input T.B	DC Output T.B	Signal connector
Solid Wire	6mm <sup>2</sup> max.	6mm <sup>2</sup> max.	1.5mm <sup>2</sup> max.
A.W.G	18~10 AWG	18~10 AWG	24~16 AWG
Screw Terminal	9 Lb-In	9 Lb-In	/

**Accessory List**

Communication interface mating wire (standard accessory)

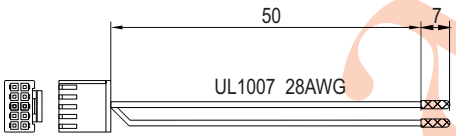
1	Item	Quantity
	<p>Mating wire</p>  <p>TKP-H254J1R-10 or equivalent</p>	1

**Installation Instruction**

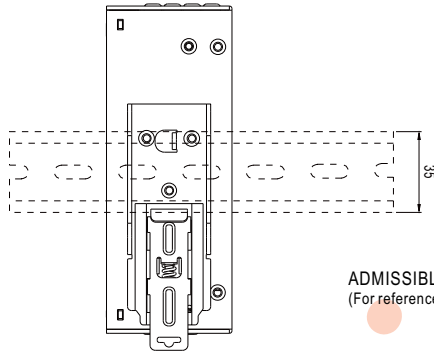

This series fits DIN rail TS35/7.5 or TS35/15.  
For installation details, please refer to the Instruction manual.

ADMISSIBLE DIN-RAIL: TS35/7.5 OR TS35/15  
(For reference only. Not included with unit.)

**Installation Manual**

Please refer to : <http://www.meanwell.com/manual.html>