

Plug

PowerTOP Plus

Part Number: 3245



MENNEKES

Elektrotechnik GmbH & Co. KG
Aloys-Mennekes-Straße 1
57399 KIRCHHUNDEM GERMANY
www.MENNEKES.org

Product Description

- Screw terminals ErgoCONTACT®
- Strain relief and protection against kinking
- Enclosure with thread lock and safety slide

Technical Details

Plug - PowerTOP Plus	3245
Product series	PowerTOP Plus
Ampere	32 A
UL-Ampere	-
Number of Poles	4 P
Clock position	6 h
Voltage	400 V
Hertz	50-60 Hz
Current Type	AC
Protection Type	IP44
Contact carrier	Standard
Pilot contact	Without pilot contact
Connection	Screw-terminals - ErgoCONTACT®
Screw drive Contact screw	Combination head screw (PZ2 and slotted)
Phase inverter plugs	Without phase inverter

Conductor cross-section min.	2,5 mm ²
Conductor cross-section max.	6 mm ²
Cable kink protection	Integrated in cable gland
Dirt spout	Without dirt spout
Protection cap	Without protection cap
Weight (net)	293 g
EAN / Identification number	4015394296508

Permissible ambient conditions

Permanent ambient temperature min. - max.	-25 °C - +40 °C
---	-----------------

Material properties

Cover	PA6 similar RAL 7000 grey
Front part	PA6 similar RAL 3013 red

Material resistance

The material resistance overview can be found on the website in the section “Knowledge” → “Product knowledge” → “Materials”

Regulations and Standards

REACH (Regulation (EG) No. 1907/2006)	Information according to article 33 REACH: SVHC: Lead (CAS: 7439-92-1)
RoHS 2011/65/EU incl. 2015/863/EU	✓
POP Regulation (EU) 2019/1021	✓
Norm(s)	IEC 60309-2
Declaration of conformity	CE
Test mark	VDE, CQC

Dimensional drawing

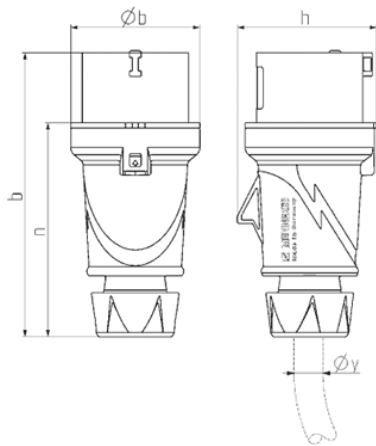

Drawing	Amp. Poles	16			32		
		3	4	5	3	4	5
2 MB 254							
Dim. in mm	a	144	153	153	188	188	188
	b	55	68	68	78	78	78
	h	58	70	74	81	81	86
	n	107	116	116	142	142	142
y min. from		7	8	8	10.5	10.5	13.5
to max. mm		-13	-15.5	-15.5	-18	-18	-20
Terminal for cond. cross		1	1	1	-2.5	-2.5	-2.5
section (mm²) min.-max.		-2.5	-2.5	-2.5	-6	-6	-6