



SWITCH CATALOGUE
SWITCHES FROM 10A UP TO 315A
DISCONNECT SWITCHES / ROTARY CAM SWITCHES

Switchgear from Salzer: Solutions for the future!

Since 1956 Salzer has specialised in the development, manufacture and sale of low voltage switchgear.

The large selection of types, switching programmes and mounting forms mean that practical reliable solutions can be achieved quickly. Whatever the switch, all individual parts are optimally co-ordinated, easy to assemble and combine.

Whether in switching and automation systems, mechanical engineering and construction, in the heating, climatic and ventilation industry, environmental technology or other areas: Salzer switches provide safety!

Product support, training and service as well as a Certified Quality Management to DIN EN ISO 9001:2000 are an essential part of our daily work. Our switches comply with national and international standards (IEC / UL / CSA) and are suitable for world-wide application.

Special requirements? Call us, we'll help you find an individual solution for your switching needs.

Faster deliveries through SMD!

In order to ensure even greater flexibility for worldwide supply availability within 24h, Salzer Electric has introduced the SMD (Salzer Modular Design) system.

SMD modules are individually prefabricated and tested all-in-one modules which SMD Service holds in stock in sufficient quantities. From basic switch modules, mounting form modules and operator modules, SMD Service can assemble a complete switch requested by the customer and pack it ready for delivery in just a few actions.

Setup of Switch Catalogue

This catalogue includes a selection of our standard programmes and is divided into the following categories:

Disconnect Switches page 4

Rotary Cam Switches page 110

If you need assistance in the selection of a product or require additional information on the range of products available from Salzer, please feel free to contact us!

How to order

The 16 digit order code number for complete switches consists of the three ident numbers for type, switching programme and mounting form:

Type - **Switching programme** - **Mounting form**

- the **type** specifies the physical size and power rating of the switches
- the **switching programme** specifies the switching arrangement and the switching angle
- the **mounting form** specifies the mountings, types of handles and optional extras

In addition to the order code number, each complete switch is assigned a machine readable 13 digit EAN Code.

Rotary Cam Switches

Safe **Switching** and **Controlling**

Rotary Cam Switches from Salzer, are manually operated, independently programmable control switches for main and auxiliary circuits with up to 24 contacts and are offered with switching angles of 30°, 45°, 60° or 90°. A maximum of 12 switching positions can be provided.

Design and Function

- 30°/ 45°/ 60° or 90° switching angle
- Forced open Contacts
- Terminal screws in open position
- Finger protected (degree of protection up to IP20)
- Short-circuit rating
- Fulfils the load break requirements up to 690V

Conformity

Our products are designed, manufactured and tested according to the following standards:



- IEC 60947
- EN 60947
- IEC 60204-1
- EN 60204-1
- UL 508
- CSA 22.2, No. 14

Applications

Rotary Cam Switches offer ideal features for their use as:

- ON-OFF Switches
- Changeover Switches
- Multi-step Switches
- Code Switches
- Gang Switches
- Instrument Switches
- Motor Switches

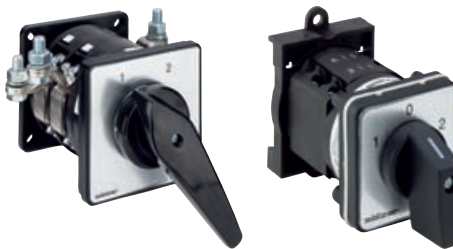
Mounting Options

	<p>Front Mounting</p> <ul style="list-style-type: none"> Two hole mounting Four hole mounting Single hole mounting Wall mounting with plaster depth box <p>Available as Control Switch, ON-OFF Switch, Multi-step Switch, Changeover Switch, Motor Switch, Main/Emergency-Off Switch or as a Main Switch.</p>
	<p>Base Mounting</p> <ul style="list-style-type: none"> Snap on mounting (DIN Rail 35 mm DIN EN 60715) Four hole mounting <p>Available as Control Switch, ON-OFF Switch, Multi-step Switch, Changeover Switch, Motor Switch, Main/Emergency-Off Switch or as a Main Switch.</p>
	<p>Enclosed Switches</p> <ul style="list-style-type: none"> Insulated enclosure <p>Available as Control Switch, ON-OFF Switch, Multi-step Switch, Changeover Switch, Motor Switch, Main/Emergency-Off Switch or as a Main Switch.</p>

Our modular technology allows us to build custom switching solutions for up to 24 poles!

Product lines

Product line P100				
▪ connection in mounting direction	IEC: 10A	UL/CSA: 10A	1 ... 16 contacts	switching angle 30°/45°/60°/90°
Product line P200				
▪ connection in mounting direction	IEC: 20A - 25A	UL/CSA: 20A - 25A	1 ... 24 contacts	switching angle 30°/45°/60°/90°
Product line M200				
▪ lateral connection	IEC: 20A - 25A	UL/CSA: 20A - 25A	1 ... 24 contacts	switching angle 30°/45°/60°/90°
Product line T200				
▪ lateral connection	IEC: 32A	UL/CSA: 35A	1 ... 24 contacts	switching angle 30°/45°/60°/90°
Product line S400				
▪ lateral connection	IEC: 50A - 63A	UL/CSA: 55A - 70A	1 ... 24 contacts	switching angle 30°/45°/60°/90°
Product line S600				
▪ lateral connection	IEC: 80A - 160A	UL/CSA: 95A - 175A	1 ... 24 contacts	switching angle 30°/45°/60°/90°
Product line S800				
▪ lateral connection	IEC: 315A	UL/CSA: 240A	1 ... 24 contacts	switching angle 30°/45°/60°/90°

Table of Contents Rotary Cam Switches

Control Switches - Instrument Switches - ON-OFF Switches Multi-step Switches - Changeover Switches - Motor Switches

Front mounting	Two hole mounting	20 mm		page 114
	Four hole mounting	36 x 36 mm		page 116
		36 x 36 mm	With dust protective cover	page 117
		48 x 48 mm		page 119
		68 x 68 mm		page 120
		104 x 104 mm		page 121
	Single hole mounting	∅ 16 mm / 22.5 mm		page 122
		∅ 16 mm / 22.5 mm	With front ring	page 123
		∅ 16 mm / 22.5 mm	Key operated	page 124
		∅ 16 mm / 22.5 mm	Key operated with front ring	page 125
		∅ 22.5 mm		page 126
		∅ 22.5 mm	With front ring	page 127
∅ 22.5 mm		Key operated	page 128	
∅ 22.5 mm		Key operated with front ring	page 129	
Wall mounting	for plaster depth box		page 131	
Base mounting	Snap on mounting			page 132
		DIN Rail		page 133
		Door clutch with modular shaft extension		page 134
		Door interlock with modular shaft extension		page 136
	Four hole mounting	68 x 68 mm		page 138
		68 x 68 mm	Door clutch	page 140
		68 x 68 mm	Door interlock	page 142
		104 x 104 mm		page 144
		104 x 104 mm	Door clutch	page 145
		104 x 104 mm	Door interlock	page 146
Enclosed switches	Insulated enclosures	68 x 68 x 53 mm		page 147
		100 x 80 x 65 mm		page 149
		100 x 80 x 85 mm		page 152
		100 x 80 x 85 mm	Key operated	page 154

Main/Emergency-Off Switches - Main Switches

Front mounting	Two hole mounting	20 mm		page 115
	Four hole mounting	36 x 36 mm	Door interlock	page 118
	Single hole mounting	∅ 22.5 mm		page 130
Base mounting	Snap on mounting	Door clutch with modular shaft extension		page 135
		Door interlock with modular shaft extension		page 137
Enclosed switches	Insulated enclosures	68 x 68 x 53 mm		page 148
		100 x 80 x 65 mm		page 151
		100 x 80 x 85 mm		page 155



Front mounting

Two hole mounting

page 114

Four hole mounting

page 116

Single hole mounting

page 122

Wall mounting

page 131



Base mounting

Snap on mounting
(DIN Rail 35 mm DIN EN 60715)

page 132

Four hole mounting

page 138



Enclosed switches

Insulated enclosures

page 147

Technical Information

page 156

Two hole mounting 20 mm

10A

- Control Switch
- ON-OFF Switch
- Multi-step Switch
- Instrument Switch
- Changeover Switch
- Motor Switch

1 ... 16 contacts

IP66 (front)

Two hole mounting 20 mm



Order code structure:

Ordering example: 2 pole ON-OFF Switch 90°, 10A, M-handle:

Type - Switching programme - Mounting form

P110 - 61192 - 003M1

Type	Rated data (IEC 60947)			Degree of protection Terminals	Terminal accessibility
	Operational current I _e AC-21A (A)	Operational power (at 380–440V) AC-23A (kW) AC-3 (kW)			
P110	10	3	2.2	IP20	 Terminals accessible from mounting direction

Detailed technical data page 192.

Switching progr.	Stages	Contacts	Description
61191	1	1	ON-OFF Switch 90°, 1 pole
61192	1	2	ON-OFF Switch 90°, 2 pole
61001	1	1	ON-OFF Switch 60°, 1 pole
61002	1	2	ON-OFF Switch 60°, 2 pole
61351	1	1	ON-OFF Switch with spring return, 1 pole
61025	1	2	Changeover Switch with centre OFF 60°, 1 pole
61026	2	4	Changeover Switch with centre OFF 60°, 2 pole
61037	1	2	Changeover Switch without OFF 60°, 1 pole
61049	2	3	Multi-step Switch without OFF, 3 steps, 1 pole
61050	2	4	Multi-step Switch without OFF, 4 steps, 1 pole
61109	1	2	Gang Switch, 2 gangs, 1 pole
61111	3	6	Gang Switch, 2 gangs, 3 pole

Switching diagrams and further switching programmes page 156.

Mounting form	Operator
003M1	 M-handle silver/black

Dimensions in mm:

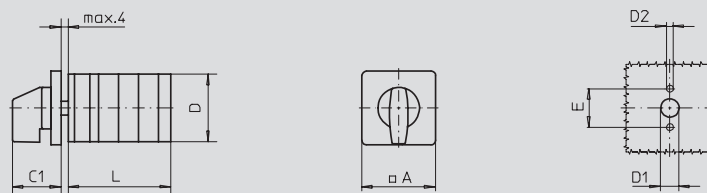

Type	A	C1	D	D1	D2	E	L with ... stages (max. 8)							
							1	2	3	4	5	6	7	8
P110	30	24	29	8	3.2	20	39	51	63	75	87	99	111	123



10A

Main/Emergency-Off Switch ■
Main Switch ■

1 ... 16 contacts

IP66 (front)
Two hole mounting 20 mm

Order code structure: **Type** - **Switching programme** - **Mounting form**
Ordering example: 1 pole Main Switch 90°, 10A, M-padlock device: **P110 - 61191 - 033M1**

Type	Rated data (IEC 60947)			Degree of protection	Terminal accessibility
	Operational current I _e AC-21A (A)	Operational power (at 380–440V) AC-23A (kW) AC-3 (kW)		Terminals	
P110	10	3	2.2	IP20	Terminals accessible from mounting direction

Detailed technical data page 192.

Switching progr.	Stages	Contacts	Description
61191	1	1	ON-OFF Switch 90°, 1 pole
61192	1	2	ON-OFF Switch 90°, 2 pole
61199	2	3	ON-OFF Switch 90°, 3 pole
61194	2	4	ON-OFF Switch 90°, 4 pole, 1 pole early make/late break
61906	3	6	ON-OFF Switch 90°, 6 pole
61919	4	8	ON-OFF Switch 90°, 8 pole, 2 pole early make/late break

Switching diagrams and further switching programmes page 156.

Mounting form	Operator	Main/Emergency-Off Switch	Mounting form	Operator	Main Switch
033M4		M-padlock device yellow/red	033M1		M-padlock device black

Dimensions in mm:

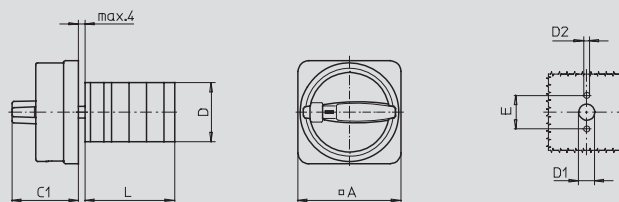

Type	A	C1	D	D1	D2	E	L with ... stages (max. 8)							
							1	2	3	4	5	6	7	8
P110	48	31	29	8	3.2	20	39	51	63	75	87	99	111	123

Four hole mounting 36 × 36 mm

20 A / 25 A / 32 A

- Control Switch
- ON-OFF Switch
- Multi-step Switch
- Instrument Switch
- Changeover Switch
- Motor Switch

1 ... 24 contacts

IP66 (front)

Four hole mounting 36 × 36 mm



Order code structure:

Ordering example: 2 pole ON-OFF Switch 60°, 20A, M-handle:

Type - **Switching programme** - **Mounting form**

M220 - 61002 - 003M1

Type	Rated data (IEC 60947)			Degree of protection Terminals	Terminal accessibility
	Operational current I _e AC-21A (A)	Operational power (at 380–440V) AC-23A (kW) AC-3 (kW)			
P220 P225	20 25	7.5 11	5.5 7.5	IP1B IP1B	Terminals accessible from mounting direction
M220 M225	20 25	7.5 11	5.5 7.5	IP20 IP20	Terminals accessible laterally
T225	32	15	11	IP20	Terminals accessible laterally

Detailed technical data page 192.

Switching progr.	Stages	Contacts	Description
61191	1	1	ON-OFF Switch 90°, 1 pole
61192	1	2	ON-OFF Switch 90°, 2 pole
61001	1	1	ON-OFF Switch 60°, 1 pole
61002	1	2	ON-OFF Switch 60°, 2 pole
61025	1	2	Changeover Switch with centre OFF 60°, 1 pole
61026	2	4	Changeover Switch with centre OFF 60°, 2 pole
61027	3	6	Changeover Switch with centre OFF 60°, 3 pole
61037	1	2	Changeover Switch without OFF 60°, 1 pole
61050	2	4	Multi-step Switch without OFF, 4 steps, 1 pole
61313	3	6	Voltmeter Selector Switch with centre OFF, 3 phase line to line + 3 phase line to N
61325	3	6	Ammeter Selector Switch with centre OFF, 3 transformers, 1 pole
61211	3	5	Motor Reversing Switch, 3 pole

Switching diagrams and further switching programmes page 156.

Mounting form	Operator
003M1	M-handle silver/black

Dimensions in mm:

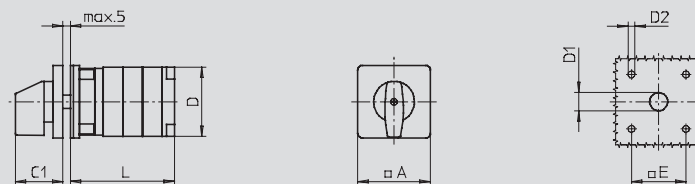

Type	A	C1	D	D1	D2	E	L with ... stages (max. 12)							each additional
							1	2	3	4	5	6	7	
P220	48	32	44	12	4.5	36	47	60	73	86	99	112	125	13
P225	48	32	46	12	4.5	36	51	66	81	96	111	126	141	15
M220	48	32	46	12	4.5	36	40	50	60	70	80	90	100	10
M225	48	32	48	12	4.5	36	43	56	69	82	95	108	121	13
T225	48	32	50	12	4.5	36	45	60	75	90	105	120	135	15

Four hole mounting 36 × 36 mm

With dust protective cover

20A / 25A / 32A

- Instrument Switch ■
- Changeover Switch ■
- Motor Switch ■
- Control Switch ■
- ON-OFF Switch ■
- Multi-step Switch ■

1 ... max. 8 contacts

IP66

Four hole mounting 36 × 36 mm



Order code structure:

Ordering example: 2 pole ON-OFF Switch 60°, 20A, M-handle:

Type - **Switching programme** - **Mounting form**

M220 - 61002 - 005M1

Type	contacts:	Rated data (IEC 60947)			Degree of protection Terminals	Terminal accessibility
		Operational current I _e AC-21A (A)	Operational power (at 380–440V) AC-23A (kW) AC-3 (kW)			
P220	1 ... 6	20	7.5	5.5	IP66	Terminals accessible from mounting direction
P225	1 ... 4	25	11	7.5	IP66	
M220	1 ... 8	20	7.5	5.5	IP66	Terminals accessible laterally
M225	1 ... 6	25	11	7.5	IP66	
T225	1 ... 4	32	15	11	IP66	Terminals accessible laterally

Detailed technical data page 192.

Switching progr.	Stages	Contacts	Description
61191	1	1	ON-OFF Switch 90°, 1 pole
61192	1	2	ON-OFF Switch 90°, 2 pole
61199	2	3	ON-OFF Switch 90°, 3 pole
61194	2	4	ON-OFF Switch 90°, 4 pole, 1 pole early make/late break
61001	1	1	ON-OFF Switch 60°, 1 pole
61002	1	2	ON-OFF Switch 60°, 2 pole
61003	2	3	ON-OFF Switch 60°, 3 pole
61025	1	2	Changeover Switch with centre OFF 60°, 1 pole
61026	2	4	Changeover Switch with centre OFF 60°, 2 pole
61037	1	2	Changeover Switch without OFF 60°, 1 pole
61049	2	3	Multi-step Switch without OFF, 3 steps, 1 pole
61050	2	4	Multi-step Switch without OFF, 4 steps, 1 pole

Switching diagrams and further switching programmes page 156.

Mounting form	Operator
005M1	M-handle silver/black

Dimensions in mm:

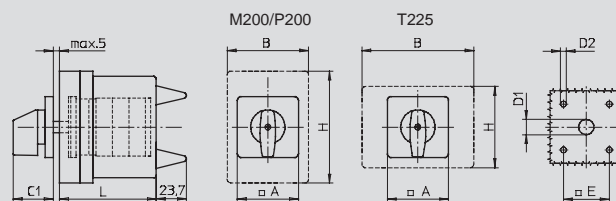

Type	A	B	C1	D1	D2	E	H	L with ... stages			
								1	2	3	4
P220	48	64	32	12	4.5	36	88	80	80	80	—
P225	48	64	32	12	4.5	36	88	80	80	—	—
M220	48	64	32	12	4.5	36	88	80	80	80	80
M225	48	64	32	12	4.5	36	88	80	80	80	—
T225	48	88	32	12	4.5	36	64	80	80	—	—

Four hole mounting 36 × 36 mm

20 A / 25 A / 32 A

- Main/Emergency-Off Switch
- Main Switch

1 ... 24 contacts

IP66 (front)

Four hole mounting 36 × 36 mm



Order code structure:

Ordering example: 2 pole Main/Emergency-Off Switch 90°, 20A, M-padlock device:

Type - Switching programme - Mounting form

M220 - 61192 - 033M4

Type	Rated data (IEC 60947)			Degree of protection Terminals	Terminal accessibility
	Operational current I _e AC-21A (A)	Operational power (at 380–440V) AC-23A (kW) AC-3 (kW)			
P220 P225	20 25	7.5 11	5.5 7.5	IP1B IP1B	Terminals accessible from mounting direction
M220 M225	20 25	7.5 11	5.5 7.5	IP20 IP20	Terminals accessible laterally
T225	32	15	11	IP20	Terminals accessible laterally

Detailed technical data page 192.

Switching progr.	Stages	Contacts	Description
61191	1	1	ON-OFF Switch 90°, 1 pole
61192	1	2	ON-OFF Switch 90°, 2 pole
61199	2	3	ON-OFF Switch 90°, 3 pole
61194	2	4	ON-OFF Switch 90°, 4 pole, 1 pole early make/late break
61906	3	6	ON-OFF Switch 90°, 6 pole
61919	4	8	ON-OFF Switch 90°, 8 pole, 2 pole early make/late break

Switching diagrams and further switching programmes page 156.

Mounting form	Operator	Main/Emergency-Off Switch	Mounting form	Operator	Main Switch
033N4		N-padlock device yellow/red	033N1		N-padlock device black
033M4		M-padlock device yellow/red	033M1		M-padlock device black
033V4		padlockable with V-handle yellow/red	033V1		padlockable with V-handle silver/black

Dimensions in mm:

Mounting form	A	C1	D	D1	D2	E	L with ... stages (max. 12)							each additional
							1	2	3	4	5	6	7	
Type P220:														
033N4/033N1	67	33	44	15	4.5	36	47	60	73	86	99	112	125	13
033M4/033M1	67	38	44	15	4.5	36	47	60	73	86	99	112	125	13
033V4/033V1	48	32	44	12	4.5	36	47	60	73	86	99	112	125	13
Type P225:														
033N4/033N1	67	33	46	15	4.5	36	51	66	81	96	111	126	141	15
033M4/033M1	67	38	46	15	4.5	36	51	66	81	96	111	126	141	15
033V4/033V1	48	32	46	12	4.5	36	51	66	81	96	111	126	141	15
Type M220:														
033N4/033N1	67	33	46	15	4.5	36	40	50	60	70	80	90	100	10
033M4/033M1	67	38	46	15	4.5	36	40	50	60	70	80	90	100	10
033V4/033V1	48	32	46	12	4.5	36	40	50	60	70	80	90	100	10
Type M225:														
033N4/033N1	67	33	48	15	4.5	36	43	56	69	82	95	108	121	13
033M4/033M1	67	38	48	15	4.5	36	43	56	69	82	95	108	121	13
033V4/033V1	48	32	48	12	4.5	36	43	56	69	82	95	108	121	13
Type T225:														
033N4/033N1	67	33	50	15	4.5	36	45	60	75	90	105	120	135	15
033M4/033M1	67	38	50	15	4.5	36	45	60	75	90	105	120	135	15
033V4/033V1	48	32	50	12	4.5	36	45	60	75	90	105	120	135	15



50 A / 63 A

Changeover Switch ■ ON-OFF Switch ■
Motor Switch ■ Multi-step Switch ■

1 ... 24 contacts

IP55 (front)

Four hole mounting 48 × 48 mm

Order code structure:

Ordering example: 3 pole ON-OFF Switch 60°, 50A, M-handle:

Type - Switching programme - Mounting form

S432 - 61003 - 003M1

Type	Rated data (IEC 60947)			Terminal accessibility
	Operational current I _e AC-21A (A)	Operational power (at 380–440V) AC-23A (kW) AC-3 (kW)		
S432	50	22	22	Terminals accessible laterally
S440	63	30	30	

Detailed technical data page 192.

Switching progr.	Stages	Contacts	Description
61191	1	1	ON-OFF Switch 90°, 1 pole
61192	1	2	ON-OFF Switch 90°, 2 pole
61199	2	3	ON-OFF Switch 90°, 3 pole
61194	2	4	ON-OFF Switch 90°, 4 pole, 1 pole early make/late break
61001	1	1	ON-OFF Switch 60°, 1 pole
61002	1	2	ON-OFF Switch 60°, 2 pole
61003	2	3	ON-OFF Switch 60°, 3 pole
61025	1	2	Changeover Switch with centre OFF 60°, 1 pole
61027	3	6	Changeover Switch with centre OFF 60°, 3 pole
61037	1	2	Changeover Switch without OFF 60°, 1 pole
61050	2	4	Multi-step Switch without OFF, 4 steps, 1 pole
61211	3	5	Motor Reversing Switch, 3 pole

Switching diagrams and further switching programmes page 156.

Mounting form	Operator
003M1	M-handle silver/black

Dimensions in mm:

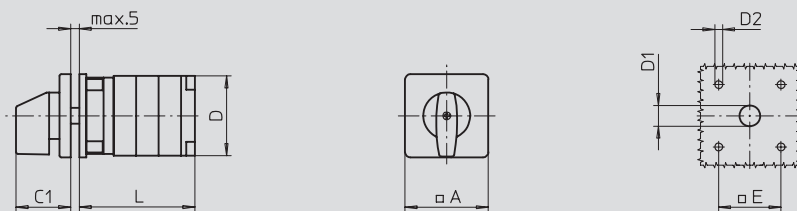

Type	A	C1	D	D1	D2	E	L with ... stages (max. 12)							each additional
							1	2	3	4	5	6	7	
S432	64	39	65	12	5	48	51	69	87	105	123	141	159	18
S440	64	39	70	12	5	48	56	77	98	119	140	161	182	21

Four hole mounting 68 × 68 mm

80 A / 100 A / 160 A

- ON-OFF Switch
- Changeover Switch
- Multi-step Switch
- Motor Switch

1 ... 24 contacts

IP55 (front)

Four hole mounting 68 × 68 mm



Order code structure:

Ordering example: 3 pole ON-OFF Switch 60°, 80A, G-handle:

Type - Switching programme - Mounting form

S606 - 61003 - 003G1

Type	Rated data (IEC 60947)			Terminal accessibility
	Operational current I _e AC-21A (A)	Operational power (at 380–440V) AC-23A (kW) AC-3 (kW)		
S606	80	45	30	Terminals accessible laterally
S608	100	55	37	
S612	160	75	45	

Detailed technical data page 192.

Switching progr.	Stages	Contacts	Description
61191	1	1	ON-OFF Switch 90°, 1 pole
61192	1	2	ON-OFF Switch 90°, 2 pole
61199	2	3	ON-OFF Switch 90°, 3 pole
61194	2	4	ON-OFF Switch 90°, 4 pole, 1 pole early make/late break
61001	1	1	ON-OFF Switch 60°, 1 pole
61002	1	2	ON-OFF Switch 60°, 2 pole
61003	2	3	ON-OFF Switch 60°, 3 pole
61025	1	2	Changeover Switch with centre OFF 60°, 1 pole
61027	3	6	Changeover Switch with centre OFF 60°, 3 pole
61037	1	2	Changeover Switch without OFF 60°, 1 pole
61050	2	4	Multi-step Switch without OFF, 4 steps, 1 pole
61211	3	5	Motor Reversing Switch, 3 pole

Switching diagrams and further switching programmes page 156.

Mounting form	Operator
003M1	M-handle silver/black
003G1	G-handle silver/black

Dimensions in mm:

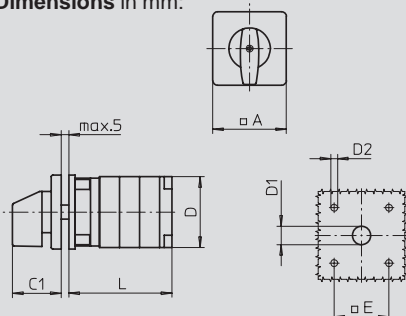

Mounting form	A	C1	D	D1	D2	E	L with ... stages (max. 12)							each additional	
							1	2	3	4	5	6	7		
Type S606:															
003M1	88	52	84	15	5.5	68	59	81	103	125	147	169	191	22	
003G1	88	66	84	15	5.5	68	59	81	103	125	147	169	191	22	
Type S608:															
003M1	88	52	88	15	5.5	68	66	92	118	144	170	196	222	26	
003G1	88	66	88	15	5.5	68	66	92	118	144	170	196	222	26	
Type S612:															
003M1	88	52	88	15	5.5	68	72	104	136	168	200	232	264	32	
003G1	88	66	88	15	5.5	68	72	104	136	168	200	232	264	32	



315A

Changeover Switch ■ ON-OFF Switch ■
 Motor Switch ■ Multi-step Switch ■

1 ... 24 contacts

IP55 (front)
 Four hole mounting 104 x 104 mm

Order code structure: **Type** - **Switching programme** - **Mounting form**
 Ordering example: 3 pole ON-OFF Switch 60°, 315A, G-handle: **S825 - 61003 - 003G1**

Type	Rated data (IEC 60947)			Terminal accessibility
	Operational current I _e AC-21A (A)	Operational power (at 380–440V) AC-23A (kW) AC-3 (kW)		
S825	315	132	55	Terminals accessible laterally

Detailed technical data page 192.

Switching progr.	Stages	Contacts	Description
61191	1	1	ON-OFF Switch 90°, 1 pole
61192	1	2	ON-OFF Switch 90°, 2 pole
61199	2	3	ON-OFF Switch 90°, 3 pole
61194	2	4	ON-OFF Switch 90°, 4 pole, 1 pole early make/late break
61001	1	1	ON-OFF Switch 60°, 1 pole
61002	1	2	ON-OFF Switch 60°, 2 pole
61003	2	3	ON-OFF Switch 60°, 3 pole
61025	1	2	Changeover Switch with centre OFF 60°, 1 pole
61027	3	6	Changeover Switch with centre OFF 60°, 3 pole
61037	1	2	Changeover Switch without OFF 60°, 1 pole
61050	2	4	Multi-step Switch without OFF, 4 steps, 1 pole

Switching diagrams and further switching programmes page 156.

Mounting form	Operator
003G1	G-handle silver/black

Dimensions in mm:

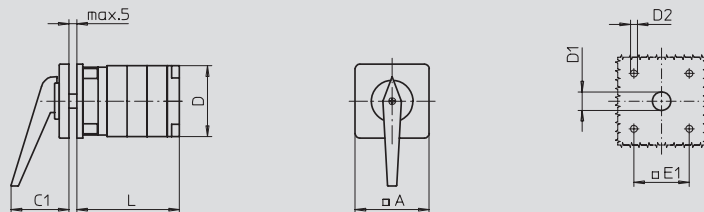

Type	A	C1	D*	D1	D2	E	L with ... stages (max. 12)							each additional
							1	2	3	4	5	6	7	
S825	130	74	210	20	5.5	104	89	125	161	197	233	269	305	36

* terminal lugs included

Single hole mounting Ø 16 mm / 22.5 mm

10A

- Control Switch
- ON-OFF Switch
- Multi-step Switch
- Instrument Switch
- Changeover Switch
- Motor Switch

1 ... 16 contacts

IP66 (front)

Single hole mounting Ø 16 mm / 22.5 mm



Order code structure:

Ordering example: 1 pole Changeover Switch with centre OFF 60°, 10A, M-handle:

Type - **Switching programme** - **Mounting form**

P110 - 61025 - 219M1

Type	Rated data (IEC 60947)			Degree of protection Terminals	Terminal accessibility
	Operational current I _e AC-21A (A)	Operational power (at 380–440V) AC-23A (kW) AC-3 (kW)			
P110	10	3	2.2	IP20	Terminals accessible from mounting direction

Detailed technical data page 192.

Switching progr.	Stages	Contacts	Description
61191	1	1	ON-OFF Switch 90°, 1 pole
61192	1	2	ON-OFF Switch 90°, 2 pole
61001	1	1	ON-OFF Switch 60°, 1 pole
61002	1	2	ON-OFF Switch 60°, 2 pole
61351	1	1	ON-OFF Switch with spring return, 1 pole
61025	1	2	Changeover Switch with centre OFF 60°, 1 pole
61026	2	4	Changeover Switch with centre OFF 60°, 2 pole
61037	1	2	Changeover Switch without OFF 60°, 1 pole
61049	2	3	Multi-step Switch without OFF, 3 steps, 1 pole
61050	2	4	Multi-step Switch without OFF, 4 steps, 1 pole
61109	1	2	Gang Switch, 2 gangs, 1 pole
61111	3	6	Gang Switch, 2 gangs, 3 pole

Switching diagrams and further switching programmes page 156.

Mounting form	Operator
219M1	M-handle silver/black

Dimensions in mm:

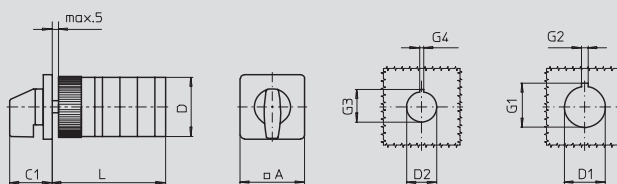

Type	A	C1	D	D1	D2	G1	G2	G3	G4	L with ... stages (max. 8)				each additional
										1	2	3	4	
P110	30	26	29	22.5	16.2	24.2	3.2	17.9	1.7	57	69	81	93	12

Single hole mounting \varnothing 16 mm / 22.5 mm

With front ring

10A



- Instrument Switch ■
- Changeover Switch ■
- Motor Switch ■
- Control Switch ■
- ON-OFF Switch ■
- Multi-step Switch ■

1 ... 16 contacts

IP66 (front)

Single hole mounting \varnothing 16 mm / 22.5 mm

Order code structure:

Ordering example: 1 pole Changeover Switch with centre OFF 60°, 10A, M-handle:

Type - Switching programme - Mounting form

P110 - 61025 - 218M1

Type	Rated data (IEC 60947)			Degree of protection Terminals	Terminal accessibility
	Operational current I_e AC-21A (A)	Operational power (at 380–440V) AC-23A (kW) AC-3 (kW)			
P110	10	3	2.2	IP20	Terminals accessible from mounting direction

Detailed technical data page 192.

Switching progr.	Stages	Contacts	Description
61191	1	1	ON-OFF Switch 90°, 1 pole
61192	1	2	ON-OFF Switch 90°, 2 pole
61001	1	1	ON-OFF Switch 60°, 1 pole
61002	1	2	ON-OFF Switch 60°, 2 pole
61351	1	1	ON-OFF Switch with spring return, 1 pole
61025	1	2	Changeover Switch with centre OFF 60°, 1 pole
61026	2	4	Changeover Switch with centre OFF 60°, 2 pole
61037	1	2	Changeover Switch without OFF 60°, 1 pole
61049	2	3	Multi-step Switch without OFF, 3 steps, 1 pole
61050	2	4	Multi-step Switch without OFF, 4 steps, 1 pole
61109	1	2	Gang Switch, 2 gangs, 1 pole
61111	3	6	Gang Switch, 2 gangs, 3 pole

Switching diagrams and further switching programmes page 156.

Mounting form	Operator
218M1	M-handle with front ring black/black

Dimensions in mm:

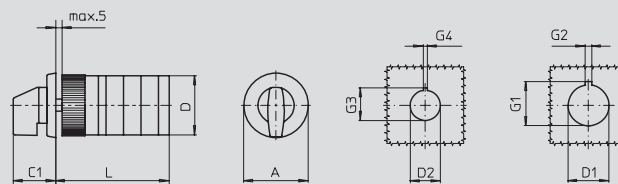

Type	A	C1	D	D1	D2	G1	G2	G3	G4	L with ... stages (max. 8)				each additional
										1	2	3	4	
P110	30	26	29	22.5	16.2	24.2	3.2	17.9	1.7	57	69	81	93	12

Single hole mounting Ø 16 mm / 22.5 mm

Key operated

10A

- Control Switch
- ON-OFF Switch
- Multi-step Switch
- Instrument Switch
- Changeover Switch
- Motor Switch

1 ... 16 contacts

IP40 (front)

Single hole mounting Ø 16 mm / 22.5 mm



Order code structure:

Ordering example: 1 pole ON-OFF Switch 90°, 10A, key operated, key removable at 09h:

Type - Switching programme - Mounting form

P110 - 61191 - S001A

Type	Rated data (IEC 60947)			Degree of protection Terminals	Terminal accessibility
	Operational current I _e AC-21A (A)	Operational power (at 380–440V) AC-23A (kW) AC-3 (kW)			
P110	10	3	2.2	IP20	Terminals accessible from mounting direction

Detailed technical data page 192.

Switching progr.	Stages	Contacts	Description
61191	1	1	ON-OFF Switch 90°, 1 pole
61192	1	2	ON-OFF Switch 90°, 2 pole
61001	1	1	ON-OFF Switch 60°, 1 pole
61002	1	2	ON-OFF Switch 60°, 2 pole
61351	1	1	ON-OFF Switch with spring return, 1 pole
61025	1	2	Changeover Switch with centre OFF 60°, 1 pole
61026	2	4	Changeover Switch with centre OFF 60°, 2 pole
61037	1	2	Changeover Switch without OFF 60°, 1 pole
61049	2	3	Multi-step Switch without OFF, 3 steps, 1 pole
61050	2	4	Multi-step Switch without OFF, 4 steps, 1 pole
61109	1	2	Gang Switch, 2 gangs, 1 pole
61111	3	6	Gang Switch, 2 gangs, 3 pole

Switching diagrams and further switching programmes page 156.

Mounting form	Operator
S001.*	<p>Key operated silver/metal key Ronis cylinder lock L001, 2 keys (other lock types on request)</p> <p>* The dot in the order code number must be replaced by the classification letter which identifies the key removable positions, see page 185.</p>

Dimensions in mm:

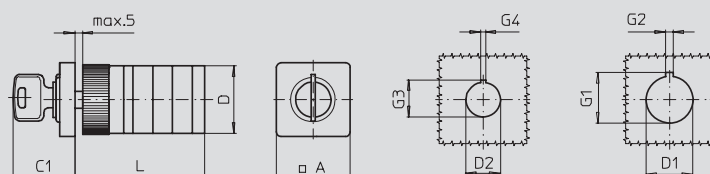

Type	A	C1	D	D1	D2	G1	G2	G3	G4	L with ... stages (max. 8)				each additional
										1	2	3	4	
P110	30	26	29	22.5	16.2	24.2	3.2	17.9	1.7	57	69	81	93	12

Single hole mounting \varnothing 16 mm / 22.5 mm

Key operated with front ring

10A



- Instrument Switch ■
- Changeover Switch ■
- Motor Switch ■
- Control Switch ■
- ON-OFF Switch ■
- Multi-step Switch ■

1 ... 16 contacts

IP40 (front)

Single hole mounting \varnothing 16 mm / 22.5 mm

Order code structure:

Ordering example: 1 pole ON-OFF Switch 90°, 10A, key operated, key removable at 09h:

Type - Switching programme - Mounting form

P110 - 61191 - R001A

Type	Rated data (IEC 60947)			Degree of protection Terminals	Terminal accessibility
	Operational current I _e AC-21A (A)	Operational power (at 380–440V) AC-23A (kW) AC-3 (kW)			
P110	10	3	2.2	IP20	 Terminals accessible from mounting direction

Detailed technical data page 192.

Switching progr.	Stages	Contacts	Description
61191	1	1	ON-OFF Switch 90°, 1 pole
61192	1	2	ON-OFF Switch 90°, 2 pole
61001	1	1	ON-OFF Switch 60°, 1 pole
61002	1	2	ON-OFF Switch 60°, 2 pole
61351	1	1	ON-OFF Switch with spring return, 1 pole
61025	1	2	Changeover Switch with centre OFF 60°, 1 pole
61026	2	4	Changeover Switch with centre OFF 60°, 2 pole
61037	1	2	Changeover Switch without OFF 60°, 1 pole
61049	2	3	Multi-step Switch without OFF, 3 steps, 1 pole
61050	2	4	Multi-step Switch without OFF, 4 steps, 1 pole
61109	1	2	Gang Switch, 2 gangs, 1 pole
61111	3	6	Gang Switch, 2 gangs, 3 pole

Switching diagrams and further switching programmes page 156.

Mounting form	Operator
R001.*	 <p>Key operated with front ring black/metal key Ronis cylinder lock L001, 2 keys (other lock types on request)</p> <p>* The dot in the order code number must be replaced by the classification letter which identifies the key removable positions, see page 185.</p>

Dimensions in mm:

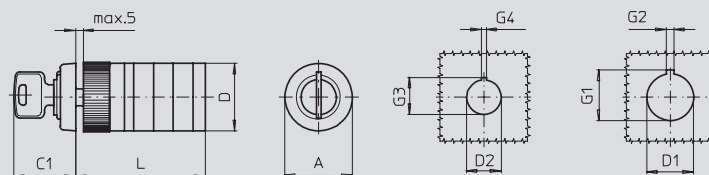

Type	A	C1	D	D1	D2	G1	G2	G3	G4	L with ... stages (max. 8)				each additional
										1	2	3	4	
P110	30	26	29	22.5	16.2	24.2	3.2	17.9	1.7	57	69	81	93	12

Single hole mounting Ø 22.5 mm

20A / 25A / 32A

- Control Switch
- ON-OFF Switch
- Multi-step Switch
- Instrument Switch
- Changeover Switch
- Motor Switch

1 ... 24 contacts

IP66 (front)

Single hole mounting Ø 22.5 mm



Order code structure:

Ordering example: 3 pole Changeover Switch with centre OFF 60°, 20A, M-handle:

Type - Switching programme - Mounting form

M220 - 61027 - 219M1

Type	Rated data (IEC 60947)			Degree of protection Terminals	Terminal accessibility
	Operational current I _e AC-21A (A)	Operational power (at 380–440V) AC-23A (kW) AC-3 (kW)			
P220 P225	20 25	7.5 11	5.5 7.5	IP1B IP1B	Terminals accessible from mounting direction
M220 M225	20 25	7.5 11	5.5 7.5	IP20 IP20	Terminals accessible laterally
T225	32	15	11	IP20	Terminals accessible laterally

Detailed technical data page 192.

Switching progr.	Stages	Contacts	Description
61191	1	1	ON-OFF Switch 90°, 1 pole
61192	1	2	ON-OFF Switch 90°, 2 pole
61001	1	1	ON-OFF Switch 60°, 1 pole
61002	1	2	ON-OFF Switch 60°, 2 pole
61025	1	2	Changeover Switch with centre OFF 60°, 1 pole
61026	2	4	Changeover Switch with centre OFF 60°, 2 pole
61027	3	6	Changeover Switch with centre OFF 60°, 3 pole
61037	1	2	Changeover Switch without OFF 60°, 1 pole
61050	2	4	Multi-step Switch without OFF, 4 steps, 1 pole
61313	3	6	Voltmeter Selector Switch with centre OFF, 3 phase line to line + 3 phase line to N
61325	3	6	Ammeter Selector Switch with centre OFF, 3 transformers, 1 pole
61211	3	5	Motor Reversing Switch, 3 pole

Switching diagrams and further switching programmes page 156.

Mounting form	Operator
219M1	M-handle silver/black

Dimensions in mm:

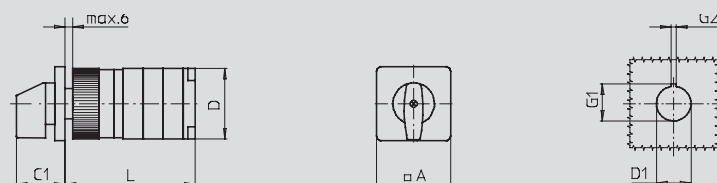

Type	A	C1	D	D1	G1	G2	L with ... stages (max. 12)							each additional
							1	2	3	4	5	6	7	
P220	48	32	44	22.5	24.2	3.2	66	79	92	105	118	131	144	13
P225	48	32	46	22.5	24.2	3.2	70	85	100	115	130	145	160	15
M220	48	32	46	22.5	24.2	3.2	59	69	79	89	99	109	119	10
M225	48	32	48	22.5	24.2	3.2	62	75	88	101	114	127	140	13
T225	48	32	50	22.5	24.2	3.2	64	79	94	109	124	139	154	15

Single hole mounting \varnothing 22.5 mm

With front ring

20A / 25A / 32A

- Instrument Switch ■
- Changeover Switch ■
- Motor Switch ■
- Control Switch ■
- ON-OFF Switch ■
- Multi-step Switch ■

1 ... 24 contacts

IP66 (front)

Single hole mounting \varnothing 22.5 mm



Order code structure:

Ordering example: 2 pole Changeover Switch with centre OFF 60°, 20A, M-handle:

Type - Switching programme - Mounting form

P220 - 61026 - 218M1

Type	Rated data (IEC 60947)			Degree of protection Terminals	Terminal accessibility
	Operational current I _e AC-21A (A)	Operational power (at 380–440V) AC-23A (kW) AC-3 (kW)			
P220 P225	20 25	7.5 11	5.5 7.5	IP1B IP1B	Terminals accessible from mounting direction
M220 M225	20 25	7.5 11	5.5 7.5	IP20 IP20	Terminals accessible laterally
T225	32	15	11	IP20	Terminals accessible laterally

Detailed technical data page 192.

Switching progr.	Stages	Contacts	Description
61191	1	1	ON-OFF Switch 90°, 1 pole
61192	1	2	ON-OFF Switch 90°, 2 pole
61001	1	1	ON-OFF Switch 60°, 1 pole
61002	1	2	ON-OFF Switch 60°, 2 pole
61025	1	2	Changeover Switch with centre OFF 60°, 1 pole
61026	2	4	Changeover Switch with centre OFF 60°, 2 pole
61027	3	6	Changeover Switch with centre OFF 60°, 3 pole
61037	1	2	Changeover Switch without OFF 60°, 1 pole
61050	2	4	Multi-step Switch without OFF, 4 steps, 1 pole
61313	3	6	Voltmeter Selector Switch with centre OFF, 3 phase line to line + 3 phase line to N
61325	3	6	Ammeter Selector Switch with centre OFF, 3 transformers, 1 pole
61211	3	5	Motor Reversing Switch, 3 pole

Switching diagrams and further switching programmes page 156.

Mounting form	Operator
218M1	M-handle with front ring black/black

Dimensions in mm:

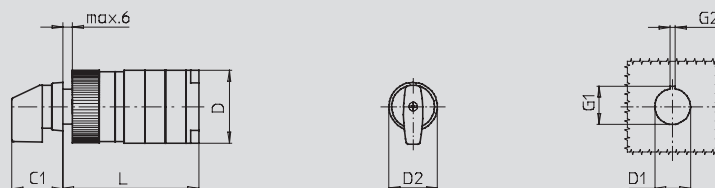

Type	C1	D	D1	D2	G1	G2	L with ... stages (max. 12)							each additional
							1	2	3	4	5	6	7	
P220	32	44	22.5	30.5	24.2	3.2	66	79	92	105	118	131	144	13
P225	32	46	22.5	30.5	24.2	3.2	70	85	100	115	130	145	160	15
M220	32	46	22.5	30.5	24.2	3.2	59	69	79	89	99	109	119	10
M225	32	48	22.5	30.5	24.2	3.2	62	75	88	101	114	127	140	13
T225	32	50	22.5	30.5	24.2	3.2	64	79	94	109	124	139	154	15

Single hole mounting Ø 22.5 mm

Key operated

20 A / 25 A / 32 A

- Control Switch
- ON-OFF Switch
- Multi-step Switch
- Instrument Switch
- Changeover Switch
- Motor Switch

1 ... max. 16 contacts

IP40 (front)

Single hole mounting Ø 22.5 mm



Order code structure:

Ordering example: 1 pole ON-OFF Switch 90°, 20A, key operated, key removable at 09h:

Type - Switching programme - Mounting form

M220 - 61191 - S001A

Type	contacts:	Rated data (IEC 60947)			Degree of protection Terminals	Terminal accessibility
		Operational current I _e AC-21A (A)	Operational power (at 380–440V) AC-23A (kW) AC-3 (kW)			
P220	1 ... 16	20	7.5	5.5	IP1B	Terminals accessible from mounting direction
P225	1 ... 16	25	11	7.5	IP1B	
M220	1 ... 16	20	7.5	5.5	IP20	Terminals accessible laterally
M225	1 ... 16	25	11	7.5	IP20	
T225	1 ... 12	32	15	11	IP20	Terminals accessible laterally

Detailed technical data page 192.

Switching progr.	Stages	Contacts	Description
61191	1	1	ON-OFF Switch 90°, 1 pole
61192	1	2	ON-OFF Switch 90°, 2 pole
61001	1	1	ON-OFF Switch 60°, 1 pole
61002	1	2	ON-OFF Switch 60°, 2 pole
61025	1	2	Changeover Switch with centre OFF 60°, 1 pole
61026	2	4	Changeover Switch with centre OFF 60°, 2 pole
61027	3	6	Changeover Switch with centre OFF 60°, 3 pole
61037	1	2	Changeover Switch without OFF 60°, 1 pole
61050	2	4	Multi-step Switch without OFF, 4 steps, 1 pole
61313	3	6	Voltmeter Selector Switch with centre OFF, 3 phase line to line + 3 phase line to N
61325	3	6	Ammeter Selector Switch with centre OFF, 3 transformers, 1 pole
61211	3	5	Motor Reversing Switch, 3 pole

Switching diagrams and further switching programmes page 156.

Mounting form	Operator
---------------	----------

S001.*



Key operated
silver/metal key
Ronis cylinder lock C001, 2 keys (other lock types on request)

* The dot in the order code number must be replaced by the classification letter which identifies the key removable positions, see page 185.

Dimensions in mm:

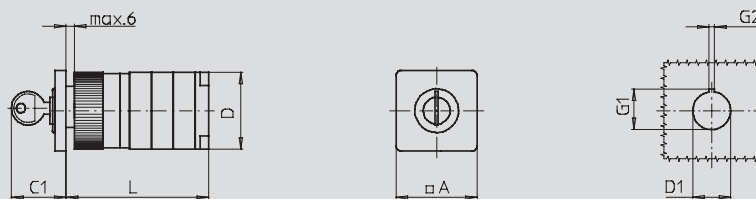

Type	A	C1	D	D1	G1	G2	L with ... stages (max. 8)							
							1	2	3	4	5	6	7	8
P220	48	33	44	22.5	24.2	3.2	66	79	92	105	118	131	144	157
P225	48	33	46	22.5	24.2	3.2	70	85	100	115	130	145	160	175
M220	48	33	46	22.5	24.2	3.2	59	69	79	89	99	109	119	129
M225	48	33	48	22.5	24.2	3.2	62	75	88	101	114	127	140	153
T225	48	33	50	22.5	24.2	3.2	64	79	94	109	124	139	—	—

Single hole mounting \varnothing 22.5 mm

Key operated with front ring

20A / 25A / 32A

- Instrument Switch ■
- Changeover Switch ■
- Motor Switch ■
- Control Switch ■
- ON-OFF Switch ■
- Multi-step Switch ■

1 ... max. 16 contacts

IP40 (front)

Single hole mounting \varnothing 22.5 mm



Order code structure:

Ordering example: 1 pole ON-OFF Switch 90°, 20A, key operated, key removable at 09h:

Type - **Switching programme** - **Mounting form**

M220 - 61191 - R001A

Type	contacts:	Rated data (IEC 60947)			Degree of protection Terminals	Terminal accessibility
		Operational current I _e AC-21A (A)	Operational power (at 380–440V) AC-23A (kW) AC-3 (kW)			
P220	1 ... 16	20	7.5	5.5	IP1B	Terminals accessible from mounting direction
P225	1 ... 16	25	11	7.5	IP1B	
M220	1 ... 16	20	7.5	5.5	IP20	Terminals accessible laterally
M225	1 ... 16	25	11	7.5	IP20	
T225	1 ... 12	32	15	11	IP20	Terminals accessible laterally

Detailed technical data page 192.

Switching progr.	Stages	Contacts	Description
61191	1	1	ON-OFF Switch 90°, 1 pole
61192	1	2	ON-OFF Switch 90°, 2 pole
61001	1	1	ON-OFF Switch 60°, 1 pole
61002	1	2	ON-OFF Switch 60°, 2 pole
61025	1	2	Changeover Switch with centre OFF 60°, 1 pole
61026	2	4	Changeover Switch with centre OFF 60°, 2 pole
61027	3	6	Changeover Switch with centre OFF 60°, 3 pole
61037	1	2	Changeover Switch without OFF 60°, 1 pole
61050	2	4	Multi-step Switch without OFF, 4 steps, 1 pole
61313	3	6	Voltmeter Selector Switch with centre OFF, 3 phase line to line + 3 phase line to N
61325	3	6	Ammeter Selector Switch with centre OFF, 3 transformers, 1 pole
61211	3	5	Motor Reversing Switch, 3 pole

Switching diagrams and further switching programmes page 156.

Mounting form	Operator
R001.*	<p>Key operated with front ring black/metal key Ronis cylinder lock C001, 2 keys (other lock types on request)</p> <p>* The dot in the order code number must be replaced by the classification letter which identifies the key removable positions, see page 185.</p>

Dimensions in mm:

Type	C1	D	D1	D2	G1	G2	L with ... stages (max. 8)							
							1	2	3	4	5	6	7	8
P220	33	44	22.5	30.5	24.2	3.2	66	79	92	105	118	131	144	157
P225	33	46	22.5	30.5	24.2	3.2	70	85	100	115	130	145	160	175
M220	33	46	22.5	30.5	24.2	3.2	59	69	79	89	99	109	119	129
M225	33	48	22.5	30.5	24.2	3.2	62	75	88	101	114	127	140	153
T225	33	50	22.5	30.5	24.2	3.2	64	79	94	109	124	139	—	—

20 A / 25 A / 32 A

- Main/Emergency-Off Switch
- Main Switch

1 ... 24 contacts

IP66 (front)

Single hole mounting Ø 22.5 mm



Order code structure:

Ordering example: 3 pole Main/Emergency-Off Switch 90°, 20A, padlockable with V-handle:

Type - Switching programme - Mounting form

M220 - 61199 - 206V4

Type	Rated data (IEC 60947)			Degree of protection Terminals	Terminal accessibility
	Operational current I _e AC-21A (A)	Operational power (at 380–440V) AC-23A (kW) AC-3 (kW)			
P220 P225	20 25	7.5 11	5.5 7.5	IP1B IP1B	Terminals accessible from mounting direction
M220 M225	20 25	7.5 11	5.5 7.5	IP20 IP20	Terminals accessible laterally
T225	32	15	11	IP20	Terminals accessible laterally

Detailed technical data page 192.

Switching progr.	Stages	Contacts	Description
61191	1	1	ON-OFF Switch 90°, 1 pole
61192	1	2	ON-OFF Switch 90°, 2 pole
61199	2	3	ON-OFF Switch 90°, 3 pole
61194	2	4	ON-OFF Switch 90°, 4 pole, 1 pole early make/late break
61906	3	6	ON-OFF Switch 90°, 6 pole
61919	4	8	ON-OFF Switch 90°, 8 pole, 2 pole early make/late break

Switching diagrams and further switching programmes page 156.

Mounting form	Operator	Main/Emergency-Off Switch	Mounting form	Operator	Main Switch
206N4		N-padlock device yellow/red	206N1		N-padlock device black
206M4		M-padlock device yellow/red	206M1		M-padlock device black
206V4		padlockable with V-handle yellow/red	206V1		padlockable with V-handle silver/black

Dimensions in mm:

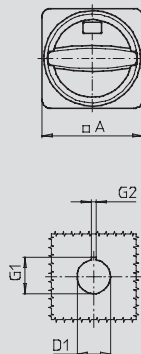
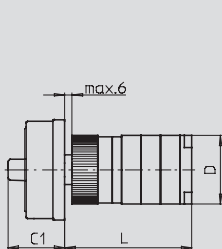

Mounting form	A	C1	D	D1	G1	G2	L with ... stages (max. 12)							each additional
							1	2	3	4	5	6	7	
Type P220:														
206N4/206N1	67	33	44	22.5	24.2	3.2	66	79	92	105	118	131	144	13
206M4/206M1	67	38	44	22.5	24.2	3.2	66	79	92	105	118	131	144	13
206V4/206V1	48	32	44	22.5	24.2	3.2	66	79	92	105	118	131	144	13
Type P225:														
206N4/206N1	67	33	46	22.5	24.2	3.2	70	85	100	115	130	145	160	15
206M4/206M1	67	38	46	22.5	24.2	3.2	70	85	100	115	130	145	160	15
206V4/206V1	48	32	46	22.5	24.2	3.2	70	85	100	115	130	145	160	15
Type M220:														
206N4/206N1	67	33	46	22.5	24.2	3.2	59	69	79	89	99	109	119	10
206M4/206M1	67	38	46	22.5	24.2	3.2	59	69	79	89	99	109	119	10
206V4/206V1	48	32	46	22.5	24.2	3.2	59	69	79	89	99	109	119	10
Type M225:														
206N4/206N1	67	33	48	22.5	24.2	3.2	62	75	88	101	114	127	140	13
206M4/206M1	67	38	48	22.5	24.2	3.2	62	75	88	101	114	127	140	13
206V4/206V1	48	32	48	22.5	24.2	3.2	62	75	88	101	114	127	140	13
Type T225:														
206N4/206N1	67	33	50	22.5	24.2	3.2	64	79	94	109	124	139	154	15
206M4/206M1	67	38	50	22.5	24.2	3.2	64	79	94	109	124	139	154	15
206V4/206V1	48	32	50	22.5	24.2	3.2	64	79	94	109	124	139	154	15

For plaster depth box

20 A / 25 A



- Instrument Switch ■
- Changeover Switch ■
- Motor Switch ■
- Control Switch ■
- ON-OFF Switch ■
- Multi-step Switch ■

1 ... max. 6 contacts

IP30 (front)

Order code structure:

Ordering example: 1 pole ON-OFF Switch 90°, 20A, N-handle:

Type - Switching programme - Mounting form

P220 - 61191 - 025N3

Type	contacts:	Rated data (IEC 60947)			Degree of protection Terminals	Terminal accessibility
		Operational current I _e AC-21A (A)	Operational power (at 380–440V) AC-23A (kW) AC-3 (kW)			
P220	1 ... 4	20	7.5	5.5	IP1B	Terminals accessible from mounting direction
P225	1 ... 2	25	11	7.5	IP1B	
M220	1 ... 6	20	7.5	5.5	IP20	Terminals accessible laterally
M225	1 ... 2	25	11	7.5	IP20	

Detailed technical data page 192.

Switching progr.	Stages	Contacts	Description
61191	1	1	ON-OFF Switch 90°, 1 pole
61192	1	2	ON-OFF Switch 90°, 2 pole
61199	2	3	ON-OFF Switch 90°, 3 pole
61001	1	1	ON-OFF Switch 60°, 1 pole
61002	1	2	ON-OFF Switch 60°, 2 pole
61003	2	3	ON-OFF Switch 60°, 3 pole
61025	1	2	Changeover Switch with centre OFF 60°, 1 pole
61026	2	4	Changeover Switch with centre OFF 60°, 2 pole
61037	1	2	Changeover Switch without OFF 60°, 1 pole
61038	2	4	Changeover Switch without OFF 60°, 2 pole
61049	2	3	Multi-step Switch without OFF, 3 steps, 1 pole
61050	2	4	Multi-step Switch without OFF, 4 steps, 1 pole

Switching diagrams and further switching programmes page 156.

Mounting form	Operator
025N3	N-handle silver/white

Dimensions in mm:

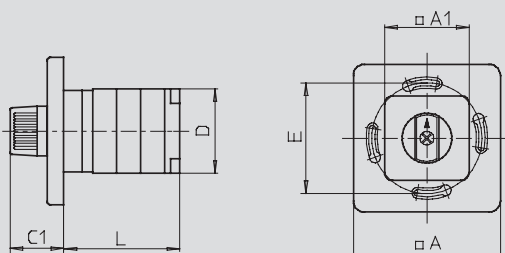

Type	A	A1	C1	D	E	L with ... stages		
						1	2	3
P220	80	46	31	44	60	43	56	—
P225	80	46	31	46	60	47	—	—
M220	80	46	31	46	60	36	46	56
M225	80	46	31	48	60	39	—	—

20A / 25A / 32A

- Control Switch
- ON-OFF Switch
- Multi-step Switch
- Instrument Switch
- Changeover Switch
- Motor Switch

1 ... 24 contacts

IP66 (front)

Four hole front mounting 36 x 36 mm



Order code structure:

Ordering example: 2 pole ON-OFF Switch 60°, 20A, M-handle:

Type - Switching programme - Mounting form

P220 - 61002 - 021M1

Type	Rated data (IEC 60947)			Degree of protection Terminals	Terminal accessibility
	Operational current I _e AC-21A (A)	Operational power (at 380–440V) AC-23A (kW) AC-3 (kW)			
P220 P225	20 25	7.5 11	5.5 7.5	IP1B IP1B	Terminals accessible from mounting direction
M220 M225	20 25	7.5 11	5.5 7.5	IP20 IP20	Terminals accessible laterally
T225	32	15	11	IP20	Terminals accessible laterally

Detailed technical data page 192.

Switching progr.	Stages	Contacts	Description
61191	1	1	ON-OFF Switch 90°, 1 pole
61192	1	2	ON-OFF Switch 90°, 2 pole
61001	1	1	ON-OFF Switch 60°, 1 pole
61002	1	2	ON-OFF Switch 60°, 2 pole
61025	1	2	Changeover Switch with centre OFF 60°, 1 pole
61026	2	4	Changeover Switch with centre OFF 60°, 2 pole
61027	3	6	Changeover Switch with centre OFF 60°, 3 pole
61037	1	2	Changeover Switch without OFF 60°, 1 pole
61038	2	4	Changeover Switch without OFF 60°, 2 pole
61049	2	3	Multi-step Switch without OFF, 3 steps, 1 pole
61050	2	4	Multi-step Switch without OFF, 4 steps, 1 pole
61211	3	5	Motor Reversing Switch, 3 pole

Switching diagrams and further switching programmes page 156.

Mounting form	Operator
021M1	M-handle silver/black

Dimensions in mm:

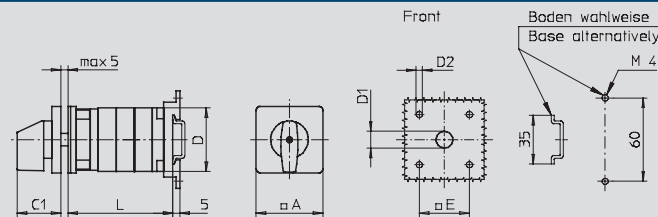

Type	A	C1	D	D1	D2	E	L with ... stages (max. 12)							each additional
							1	2	3	4	5	6	7	
P220	48	32	44	12	4.5	36	46	59	72	85	98	111	124	13
P225	48	32	46	12	4.5	36	48	63	78	93	108	123	138	15
M220	48	32	46	12	4.5	36	43	53	63	73	83	93	103	10
M225	48	32	48	12	4.5	36	46	59	72	85	98	111	124	13
T225	48	32	50	12	4.5	36	48	63	78	93	108	123	138	15

- Instrument Switch ■ Control Switch ■
- Changeover Switch ■ ON-OFF Switch ■
- Motor Switch ■ Multi-step Switch ■

1 ... 24 contacts

IP40 (front)

Installation mounting for 45 mm aperture in Panel/Distribution boards





Order code structure:

Ordering example: 2 pole ON-OFF Switch 60°, 20A, N-handle:

Type - **Switching programme** - **Mounting form**

P220 - 61002 - 026N2

Type	Rated data (IEC 60947)			Degree of protection Terminals	Terminal accessibility
	Operational current I _e AC-21A (A)	Operational power (at 380–440V) AC-23A (kW) AC-3 (kW)			
P220 P225	20 25	7.5 11	5.5 7.5	IP1B IP1B	 Terminals accessible from mounting direction
M220 M225	20 25	7.5 11	5.5 7.5	IP20 IP20	 Terminals accessible laterally
T225	32	15	11	IP20	 Terminals accessible laterally

Detailed technical data page 192.

Switching progr.	Stages	Contacts	Description
61191	1	1	ON-OFF Switch 90°, 1 pole
61192	1	2	ON-OFF Switch 90°, 2 pole
61001	1	1	ON-OFF Switch 60°, 1 pole
61002	1	2	ON-OFF Switch 60°, 2 pole
61025	1	2	Changeover Switch with centre OFF 60°, 1 pole
61026	2	4	Changeover Switch with centre OFF 60°, 2 pole
61027	3	6	Changeover Switch with centre OFF 60°, 3 pole
61037	1	2	Changeover Switch without OFF 60°, 1 pole
61050	2	4	Multi-step Switch without OFF, 4 steps, 1 pole
61313	3	6	Voltmeter Selector Switch with centre OFF, 3 phase line to line + 3 phase line to N
61325	3	6	Ammeter Selector Switch with centre OFF, 3 transformers, 1 pole
61211	3	5	Motor Reversing Switch, 3 pole

Switching diagrams and further switching programmes page 156.

Mounting form	Operator
026N2	 N-handle silver/grey

Dimensions in mm:

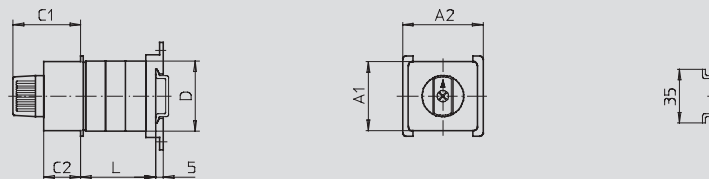

Type	A1	A2	C1	C2	D	L with ... stages (max. 12)							each additional
						1	2	3	4	5	6	7	
P220	45	52.2	45	24	44	28	41	54	67	80	93	106	13
P225	45	52.2	45	24	46	30	45	60	75	90	105	120	15
M220	45	52.2	45	24	46	25	35	45	55	65	75	85	10
M225	45	52.2	45	24	48	28	41	54	67	80	93	106	13
T225	45	52.2	45	24	50	30	45	60	75	90	105	120	15

Snap on mounting

Door clutch with modular shaft extension

20A / 25A / 32A

- Control Switch
- ON-OFF Switch
- Multi-step Switch
- Instrument Switch
- Changeover Switch
- Motor Switch

1 ... 24 contacts

IP66 (front)

Four hole front mounting 36 x 36 mm



Order code structure: **Type** - **Switching programme** - **Mounting form**
 Ordering example: 2 pole ON-OFF Switch 60°, 20A, N-handle: **M220 - 61002 - 241M1**

Type	Rated data (IEC 60947)			Degree of protection Terminals	Terminal accessibility
	Operational current I _e AC-21A (A)	Operational power (at 380–440V) AC-23A (kW) AC-3 (kW)			
P220 P225	20 25	7.5 11	5.5 7.5	IP1B IP1B	Terminals accessible from mounting direction
M220 M225	20 25	7.5 11	5.5 7.5	IP20 IP20	Terminals accessible laterally
T225	32	15	11	IP20	Terminals accessible laterally

Detailed technical data page 192.

Switching progr.	Stages	Contacts	Description
61191	1	1	ON-OFF Switch 90°, 1 pole
61192	1	2	ON-OFF Switch 90°, 2 pole
61001	1	1	ON-OFF Switch 60°, 1 pole
61002	1	2	ON-OFF Switch 60°, 2 pole
61025	1	2	Changeover Switch with centre OFF 60°, 1 pole
61026	2	4	Changeover Switch with centre OFF 60°, 2 pole
61027	3	6	Changeover Switch with centre OFF 60°, 3 pole
61037	1	2	Changeover Switch without OFF 60°, 1 pole
61038	2	4	Changeover Switch without OFF 60°, 2 pole
61049	2	3	Multi-step Switch without OFF, 3 steps, 1 pole
61050	2	4	Multi-step Switch without OFF, 4 steps, 1 pole
61211	3	5	Motor Reversing Switch, 3 pole

Switching diagrams and further switching programmes page 156.

Mounting form	Operator
241M1	M-handle silver/black

Dimensions in mm:

Modular shaft extensions see page 184.

Type	A	C _{min}	C _{max}	C1	D	D1	D2	E	L with ... stages (max. 12)				each additional
									1	2	3	4	
P220	48	42	59	32	44	12	4.5	36	40	53	66	79	13
P225	48	42	59	32	46	12	4.5	36	42	57	72	87	15
M220	48	42	59	32	46	12	4.5	36	37	47	57	67	10
M225	48	42	59	32	46	12	4.5	36	40	53	66	79	13
T225	48	42	59	32	50	12	4.5	36	42	57	72	87	15

20A / 25A / 32A

Main/Emergency-Off Switch ■
Main Switch ■

1 ... 24 contacts

IP66 (front)

Four hole front mounting 36 × 36 mm

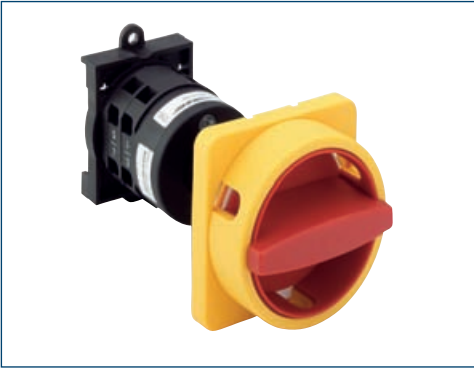

Order code structure:

Ordering example: 2 pole Main/Emergency-Off Switch 90°, 20A, N-padlock device:

Type - Switching programme - Mounting form

M220 - 61192 - 232N4

Type	Rated data (IEC 60947)			Degree of protection Terminals	Terminal accessibility
	Operational current I _e AC-21A (A)	Operational power (at 380–440V) AC-23A (kW) AC-3 (kW)			
P220 P225	20 25	7.5 11	5.5 7.5	IP1B IP1B	Terminals accessible from mounting direction
M220 M225	20 25	7.5 11	5.5 7.5	IP20 IP20	Terminals accessible laterally
T225	32	15	11	IP20	Terminals accessible laterally

Detailed technical data page 192.

Switching progr.	Stages	Contacts	Description
61191	1	1	ON-OFF Switch 90°, 1 pole
61192	1	2	ON-OFF Switch 90°, 2 pole
61199	2	3	ON-OFF Switch 90°, 3 pole
61194	2	4	ON-OFF Switch 90°, 4 pole, 1 pole early make/late break
61906	3	6	ON-OFF Switch 90°, 6 pole
61919	4	8	ON-OFF Switch 90°, 8 pole, 2 pole early make/late break

Switching diagrams and further switching programmes page 156.

Mounting form	Operator	Main/Emergency-Off Switch	Mounting form	Operator	Main Switch
232N4		N-padlock device yellow/red	232N1		N-padlock device black
232M4		M-padlock device yellow/red	232M1		M-padlock device black
232V4		padlockable with V-handle yellow/red	232V1		padlockable with V-handle silver/black

Dimensions in mm:

Modular shaft extensions
see page 184.

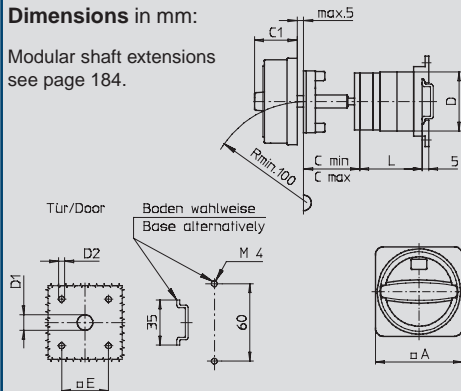

Mounting form	A	C _{min}	C _{max}	C1	D	D1	D2	E	L with ... stages (max. 12)				each additional
									1	2	3	4	
Type P220:													
232N4/232N1	67	42	59	33	44	15	4.5	36	40	53	66	79	13
232M4/232M1	67	42	59	38	44	15	4.5	36	40	53	66	79	13
232V4/232V1	48	42	59	32	44	12	4.5	36	40	53	66	79	13
Type P225:													
232N4/232N1	67	42	59	33	46	15	4.5	36	42	57	72	87	15
232M4/232M1	67	42	59	38	46	15	4.5	36	42	57	72	87	15
232V4/232V1	48	42	59	32	46	12	4.5	36	42	57	72	87	15
Type M220:													
232N4/232N1	67	42	59	33	46	15	4.5	36	37	47	57	67	10
232M4/232M1	67	42	59	38	46	15	4.5	36	37	47	57	67	10
232V4/232V1	48	42	59	32	46	12	4.5	36	37	47	57	67	10
Type M225:													
232N4/232N1	67	42	59	33	48	15	4.5	36	40	53	66	79	13
232M4/232M1	67	42	59	38	48	15	4.5	36	40	53	66	79	13
232V4/232V1	48	42	59	32	48	12	4.5	36	40	53	66	79	13
Type T225:													
232N4/232N1	67	42	59	33	50	15	4.5	36	42	57	72	87	15
232M4/232M1	67	42	59	38	50	15	4.5	36	42	57	72	87	15

Snap on mounting

Door interlock with modular shaft extension

With N/PE connection link

20A / 25A / 32A

- Control Switch
- ON-OFF Switch
- Multi-step Switch
- Instrument Switch
- Changeover Switch
- Motor Switch

1 ... 24 contacts

IP66 (front)

Four hole front mounting 36 x 36 mm



Order code structure: **Type** - **Switching programme** - **Mounting form**
 Ordering example: 1 pole ON-OFF Switch 60°, 20A, M-handle: **M220 - 61001 - 242M1**

Type	Rated data (IEC 60947)			Degree of protection Terminals	Terminal accessibility
	Operational current I _e AC-21A (A)	Operational power (at 380–440V) AC-23A (kW) AC-3 (kW)			
P220 P225	20 25	7.5 11	5.5 7.5	IP1B IP1B	Terminals accessible from mounting direction
M220 M225	20 25	7.5 11	5.5 7.5	IP20 IP20	Terminals accessible laterally
T225	32	15	11	IP20	Terminals accessible laterally

Detailed technical data page 192.

Switching progr.	Stages	Contacts	Description
61191	1	1	ON-OFF Switch 90°, 1 pole
61192	1	2	ON-OFF Switch 90°, 2 pole
61001	1	1	ON-OFF Switch 60°, 1 pole
61002	1	2	ON-OFF Switch 60°, 2 pole
61025	1	2	Changeover Switch with centre OFF 60°, 1 pole
61026	2	4	Changeover Switch with centre OFF 60°, 2 pole
61027	3	6	Changeover Switch with centre OFF 60°, 3 pole
61037	1	2	Changeover Switch without OFF 60°, 1 pole
61038	2	4	Changeover Switch without OFF 60°, 2 pole
61049	2	3	Multi-step Switch without OFF, 3 steps, 1 pole
61050	2	4	Multi-step Switch without OFF, 4 steps, 1 pole
61211	3	5	Motor Reversing Switch, 3 pole

Switching diagrams and further switching programmes page 156.

Mounting form	Operator
242M1	M-handle silver/black

Dimensions in mm:

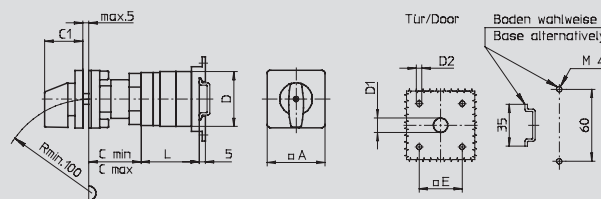

Modular shaft extensions see page 184.

Type	A	C _{min}	C _{max}	C1	D	D1	D2	E	L with ... stages (max. 12)				each additional
									1	2	3	4	
P220	48	42	57	32	44	12	4.5	36	40	53	66	79	13
P225	48	42	57	32	46	12	4.5	36	42	57	72	87	15
M220	48	42	57	32	46	12	4.5	36	37	47	57	67	10
M225	48	42	57	32	48	12	4.5	36	40	53	66	79	13
T225	48	42	57	32	50	12	4.5	36	42	57	72	87	15

Door interlock with modular shaft extension

With N/PE connection link

20 A / 25 A / 32 A

Main/Emergency-Off Switch ■
Main Switch ■

1 ... 24 contacts

IP66 (front)

Four hole front mounting 36 × 36 mm



Order code structure:

Ordering example: 2 pole Main Switch 90°, 20A, padlockable with V-handle:

Type - Switching programme - Mounting form

P220 - 61192 - 234V1

Type	Rated data (IEC 60947)			Degree of protection Terminals	Terminal accessibility
	Operational current I _e AC-21A (A)	Operational power (at 380–440V) AC-23A (kW) AC-3 (kW)			
P220 P225	20 25	7.5 11	5.5 7.5	IP1B IP1B	Terminals accessible from mounting direction
M220 M225	20 25	7.5 11	5.5 7.5	IP20 IP20	Terminals accessible laterally
T225	32	15	11	IP20	Terminals accessible laterally

Detailed technical data page 192.

Switching progr.	Stages	Contacts	Description
61191	1	1	ON-OFF Switch 90°, 1 pole
61192	1	2	ON-OFF Switch 90°, 2 pole
61199	2	3	ON-OFF Switch 90°, 3 pole
61194	2	4	ON-OFF Switch 90°, 4 pole, 1 pole early make/late break
61906	3	6	ON-OFF Switch 90°, 6 pole
61919	4	8	ON-OFF Switch 90°, 8 pole, 2 pole early make/late break

Switching diagrams and further switching programmes page 156.

Mounting form	Operator	Main/Emergency-Off Switch	Mounting form	Operator	Main Switch
234N4		N-padlock device yellow/red	234N1		N-padlock device black
234M4		M-padlock device yellow/red	234M1		M-padlock device black
234V4		padlockable with V-handle yellow/red	234V1		padlockable with V-handle silver/black

Dimensions in mm:

Modular shaft extensions
see page 184.

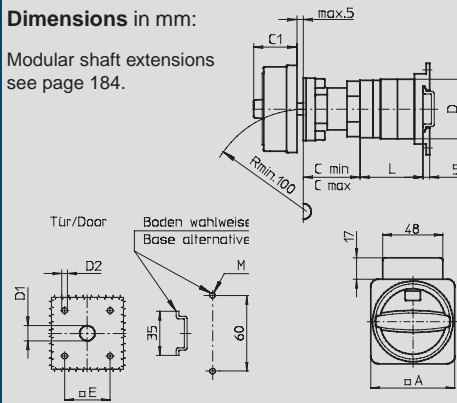

Mounting form	A	C _{min}	C _{max}	C1	D	D1	D2	E	L with ... stages (max. 12)				each additional
									1	2	3	4	
Type P220:													
234N4/234N1	67	42	57	33	44	15	4.5	36	40	53	66	79	13
234M4/234M1	67	42	57	32	44	15	4.5	36	40	53	66	79	13
234V4/234V1	48	42	57	32	44	12	4.5	36	40	53	66	79	13
Type P225:													
234N4/234N1	67	42	57	33	46	15	4.5	36	42	57	72	87	15
234M4/234M1	67	42	57	32	46	15	4.5	36	42	57	72	87	15
234V4/234V1	48	42	57	32	46	12	4.5	36	42	57	72	87	15
Type M220:													
234N4/234N1	67	42	57	33	46	15	4.5	36	37	47	57	67	10
234M4/234M1	67	42	57	38	46	15	4.5	36	37	47	57	67	10
234V4/234V1	48	42	57	32	46	12	4.5	36	37	47	57	67	10
Type M225:													
234N4/234N1	67	42	57	33	48	15	4.5	36	40	53	66	79	13
234M4/234M1	67	42	57	38	48	15	4.5	36	40	53	66	79	13
234V4/234V1	48	42	57	32	48	12	4.5	36	40	53	66	79	13
Type T225:													
234N4/234N1	67	42	57	33	50	15	4.5	36	42	57	72	87	15
234M4/234M1	67	42	57	38	48	15	4.5	36	42	57	72	87	15
234V4/234V1	48	42	57	32	50	12	4.5	36	42	57	72	87	15

Four hole mounting 68 × 68 mm

50A / 63A

- ON-OFF Switch ■ Changeover Switch
- Multi-step Switch ■ Motor Switch

1 ... 24 contacts

IP55 (front)

Four hole front mounting 48 × 48 mm



Order code structure:

Ordering example: 3 pole ON-OFF Switch 60°, 50A, M-handle:

Type - Switching programme - Mounting form

S432 - 61003 - 002M1

Type	Rated data (IEC 60947)			Terminal accessibility
	Operational current I _e AC-21A (A)	Operational power (at 380–440V) AC-23A (kW) AC-3 (kW)		
S432	50	22	22	Terminals accessible laterally
S440	63	30	30	

Detailed technical data page 192.

Switching progr.	Stages	Contacts	Description
61191	1	1	ON-OFF Switch 90°, 1 pole
61192	1	2	ON-OFF Switch 90°, 2 pole
61001	1	1	ON-OFF Switch 60°, 1 pole
61002	1	2	ON-OFF Switch 60°, 2 pole
61003	2	3	ON-OFF Switch 60°, 3 pole
61025	1	2	Changeover Switch with centre OFF 60°, 1 pole
61026	2	4	Changeover Switch with centre OFF 60°, 2 pole
61027	3	6	Changeover Switch with centre OFF 60°, 3 pole
61037	1	2	Changeover Switch without OFF 60°, 1 pole
61038	2	4	Changeover Switch without OFF 60°, 2 pole
61050	2	4	Multi-step Switch without OFF, 4 steps, 1 pole
61211	3	5	Motor Reversing Switch, 3 pole

Switching diagrams and further switching programmes page 156.

Mounting form	Operator
002M1	M-handle silver/black

Dimensions in mm:

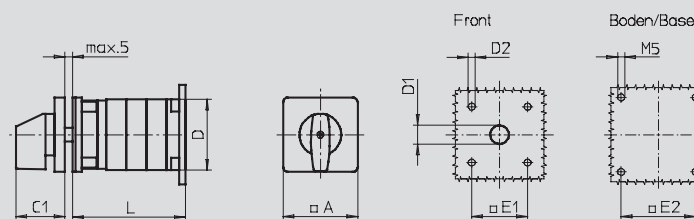

Type	A	C1	D	D1	D2	E1	E2	L with ... stages (max. 12)						each additional
								1	2	3	4	5	6	
S432	64	39	65	12	5	48	68	56	74	92	110	128	146	18
S440	64	39	70	12	5	48	68	61	82	103	124	145	166	21

80 A / 100 A / 160 A

Changeover Switch ■ ON-OFF Switch ■
Motor Switch ■ Multi-step Switch ■

1 ... 24 contacts

IP55 (front)

Four hole front mounting 68 × 68 mm



Order code structure: Type - Switching programme - Mounting form
Ordering example: 3 pole ON-OFF Switch 60°, 80A, M-handle: S606 - 61003 - 002M1

Type	Rated data (IEC 60947)			Terminal accessibility
	Operational current I _e AC-21A (A)	Operational power (at 380–440V) AC-23A (kW) AC-3 (kW)		
S606	80	45	30	Terminals accessible laterally
S608	100	55	37	
S612	160	75	45	

Detailed technical data page 192.

Switching progr.	Stages	Contacts	Description
61191	1	1	ON-OFF Switch 90°, 1 pole
61192	1	2	ON-OFF Switch 90°, 2 pole
61001	1	1	ON-OFF Switch 60°, 1 pole
61002	1	2	ON-OFF Switch 60°, 2 pole
61003	2	3	ON-OFF Switch 60°, 3 pole
61025	1	2	Changeover Switch with centre OFF 60°, 1 pole
61026	2	4	Changeover Switch with centre OFF 60°, 2 pole
61027	3	6	Changeover Switch with centre OFF 60°, 3 pole
61037	1	2	Changeover Switch without OFF 60°, 1 pole
61038	2	4	Changeover Switch without OFF 60°, 2 pole
61050	2	4	Multi-step Switch without OFF, 4 steps, 1 pole
61211	3	5	Motor Reversing Switch, 3 pole

Switching diagrams and further switching programmes page 156.

Mounting form	Operator
002M1	M-handle silver/black
002G1	G-handle silver/black

Dimensions in mm:

Mounting form	A	C1	D	D1	D2	E1	E2	L with ... stages (max. 12)						each additional
								1	2	3	4	5	6	
Type S606:														
002M1	88	52	84	15	5.5	68	68	64	86	108	130	152	174	22
002G1	88	66	84	15	5.5	68	68	64	86	108	130	152	174	22
Type S608:														
002M1	88	52	88	15	5.5	68	68	71	97	123	149	175	201	26
002G1	88	66	88	15	5.5	68	68	71	97	123	149	175	201	26
Type S612:														
002M1	88	52	88	15	5.5	68	68	77	109	141	173	205	237	32
002G1	88	66	88	15	5.5	68	68	77	109	141	173	205	237	32

Four hole mounting 68 × 68 mm

Door clutch

50A / 63A

- ON-OFF Switch ■ Changeover Switch
- Multi-step Switch ■ Motor Switch

1 ... 24 contacts

IP55 (front)

Four hole front mounting 48 × 48 mm



Order code structure:

Ordering example: 3 pole ON-OFF Switch 60°, 50A, M-handle:

Type - Switching programme - Mounting form

S432 - 61003 - 041M1

Type	Rated data (IEC 60947)			Terminal accessibility
	Operational current I _e AC-21A (A)	Operational power (at 380–440V) AC-23A (kW) AC-3 (kW)		
S432	50	22	22	Terminals accessible laterally
S440	63	30	30	

Detailed technical data page 192.

Switching progr.	Stages	Contacts	Description
61191	1	1	ON-OFF Switch 90°, 1 pole
61192	1	2	ON-OFF Switch 90°, 2 pole
61001	1	1	ON-OFF Switch 60°, 1 pole
61002	1	2	ON-OFF Switch 60°, 2 pole
61003	2	3	ON-OFF Switch 60°, 3 pole
61025	1	2	Changeover Switch with centre OFF 60°, 1 pole
61026	2	4	Changeover Switch with centre OFF 60°, 2 pole
61027	3	6	Changeover Switch with centre OFF 60°, 3 pole
61037	1	2	Changeover Switch without OFF 60°, 1 pole
61038	2	4	Changeover Switch without OFF 60°, 2 pole
61050	2	4	Multi-step Switch without OFF, 4 steps, 1 pole
61211	3	5	Motor Reversing Switch, 3 pole

Switching diagrams and further switching programmes page 156.

Mounting form	Operator
041M1	M-handle silver/black

Dimensions in mm:

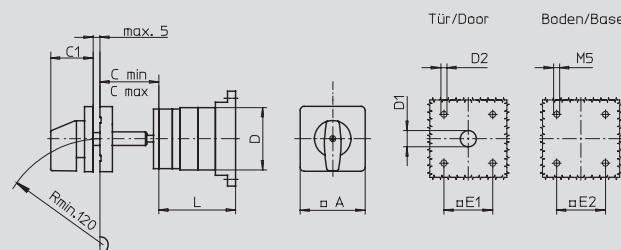

Type	A	C _{min}	C _{max}	C1	D	D1	D2	E1	E2	L with ... stages (max. 12)			each additional
										1	2	3	
S432	64	42	56	39	65	15	5	48	68	51	69	87	18
S440	64	42	56	39	70	15	5	48	68	56	77	98	21

Changeover Switch ■ ON-OFF Switch ■
 Motor Switch ■ Multi-step Switch ■

1 ... 24 contacts

IP55 (front)

Four hole front mounting 68 × 68 mm



Order code structure:

Ordering example: 3 pole ON-OFF Switch 60°, 80A, M-handle:

Type - Switching programme - Mounting form

S606 - 61003 - 041M1

Type	Rated data (IEC 60947)			Terminal accessibility
	Operational current I _e AC-21A (A)	Operational power (at 380–440V) AC-23A (kW) AC-3 (kW)		
S606	80	45	30	Terminals accessible laterally
S608	100	55	37	
S612	160	75	45	

Detailed technical data page 192.

Switching progr.	Stages	Contacts	Description
61191	1	1	ON-OFF Switch 90°, 1 pole
61192	1	2	ON-OFF Switch 90°, 2 pole
61001	1	1	ON-OFF Switch 60°, 1 pole
61002	1	2	ON-OFF Switch 60°, 2 pole
61003	2	3	ON-OFF Switch 60°, 3 pole
61025	1	2	Changeover Switch with centre OFF 60°, 1 pole
61026	2	4	Changeover Switch with centre OFF 60°, 2 pole
61027	3	6	Changeover Switch with centre OFF 60°, 3 pole
61037	1	2	Changeover Switch without OFF 60°, 1 pole
61038	2	4	Changeover Switch without OFF 60°, 2 pole
61050	2	4	Multi-step Switch without OFF, 4 steps, 1 pole
61211	3	5	Motor Reversing Switch, 3 pole

Switching diagrams and further switching programmes page 156.

Mounting form	Operator
041M1	M-handle silver/black
041G1	G-handle silver/black

Dimensions in mm:

Mounting form	A	C _{min}	C _{max}	C1	D	D1	D2	E1	E2	L with ... stages (max. 12)			each additional
										1	2	3	
Type S606:													
041M1	88	48	60	52	84	18	5.5	68	68	58	80	107	22
041G1	88	48	60	66	84	18	5.5	68	68	58	80	107	22
Type S608:													
041M1	88	48	60	52	88	18	5.5	68	68	65	91	117	26
041G1	88	48	60	66	88	18	5.5	68	68	65	91	117	26
Type S612:													
041M1	88	48	60	52	88	18	5.5	68	68	71	103	135	32
041G1	88	48	60	66	88	18	5.5	68	68	71	103	135	32

Four hole mounting 68 × 68 mm

Door interlock

50A / 63A

- ON-OFF Switch ■ Changeover Switch
- Multi-step Switch ■ Motor Switch

1 ... 24 contacts

IP55 (front)

Four hole front mounting 48 × 48 mm



Order code structure:

Ordering example: 3 pole ON-OFF Switch 60°, 50A, M-handle:

Type - **Switching programme** - **Mounting form**

S432 - 61003 - 042M1

Type	Rated data (IEC 60947)			Terminal accessibility
	Operational current I _e AC-21A (A)	Operational power (at 380–440V) AC-23A (kW) AC-3 (kW)		
S432	50	22	22	Terminals accessible laterally
S440	63	30	30	

Detailed technical data page 192.

Switching progr.	Stages	Contacts	Description
61191	1	1	ON-OFF Switch 90°, 1 pole
61192	1	2	ON-OFF Switch 90°, 2 pole
61001	1	1	ON-OFF Switch 60°, 1 pole
61002	1	2	ON-OFF Switch 60°, 2 pole
61003	2	3	ON-OFF Switch 60°, 3 pole
61025	1	2	Changeover Switch with centre OFF 60°, 1 pole
61026	2	4	Changeover Switch with centre OFF 60°, 2 pole
61027	3	6	Changeover Switch with centre OFF 60°, 3 pole
61037	1	2	Changeover Switch without OFF 60°, 1 pole
61038	2	4	Changeover Switch without OFF 60°, 2 pole
61050	2	4	Multi-step Switch without OFF, 4 steps, 1 pole
61211	3	5	Motor Reversing Switch, 3 pole

Switching diagrams and further switching programmes page 156.

Mounting form	Operator
042M1	M-handle silver/black

Dimensions in mm:

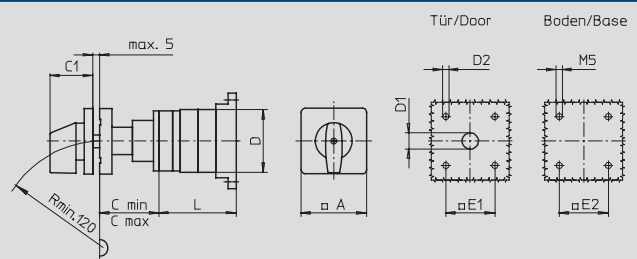

Type	A	C _{min}	C _{max}	C1	D	D1	D2	E1	E2	L with ... stages (max. 12)			each additional
										1	2	3	
S432	64	42	56	39	65	15	5	48	68	51	69	87	18
S440	64	42	56	39	70	15	5	48	68	56	77	98	21

Four hole mounting 68 × 68 mm

Door interlock

80 A / 100 A / 160 A

Changeover Switch ■ ON-OFF Switch ■
Motor Switch ■ Multi-step Switch ■

1 ... 24 contacts

IP55 (front)

Four hole front mounting 68 × 68 mm



Order code structure:

Ordering example: 3 pole ON-OFF Switch 60°, 80A, M-handle:

Type - Switching programme - Mounting form

S606 - 61003 - 042M1

Type	Rated data (IEC 60947)			Terminal accessibility
	Operational current I _e AC-21A (A)	Operational power (at 380–440V) AC-23A (kW) AC-3 (kW)		
S606	80	45	30	Terminals accessible laterally
S608	100	55	37	
S612	160	75	45	

Detailed technical data page 192.

Switching progr.	Stages	Contacts	Description
61191	1	1	ON-OFF Switch 90°, 1 pole
61192	1	2	ON-OFF Switch 90°, 2 pole
61001	1	1	ON-OFF Switch 60°, 1 pole
61002	1	2	ON-OFF Switch 60°, 2 pole
61003	2	3	ON-OFF Switch 60°, 3 pole
61025	1	2	Changeover Switch with centre OFF 60°, 1 pole
61026	2	4	Changeover Switch with centre OFF 60°, 2 pole
61027	3	6	Changeover Switch with centre OFF 60°, 3 pole
61037	1	2	Changeover Switch without OFF 60°, 1 pole
61038	2	4	Changeover Switch without OFF 60°, 2 pole
61050	2	4	Multi-step Switch without OFF, 4 steps, 1 pole
61211	3	5	Motor Reversing Switch, 3 pole

Switching diagrams and further switching programmes page 156.

Mounting form	Operator
042M1	M-handle silver/black
042G1	G-handle silver/black

Dimensions in mm:

Mounting form	A	C _{min}	C _{max}	C1	D	D1	D2	E1	E2	L with ... stages (max. 12)			each additional
										1	2	3	
Type S606:													
042M1	88	48	60	52	84	18	5.5	68	68	58	80	107	22
042G1	88	48	60	66	84	18	5.5	68	68	58	80	107	22
Type S608:													
042M1	88	48	60	52	88	18	5.5	68	68	65	91	117	26
042G1	88	48	60	66	88	18	5.5	68	68	65	91	117	26
Type S612:													
042M1	88	48	60	52	88	18	5.5	68	68	71	103	135	32
042G1	88	48	60	66	88	18	5.5	68	68	71	103	135	32

Four hole mounting 104 × 104 mm

315A

- ON-OFF Switch ■ Changeover Switch
- Multi-step Switch ■ Motor Switch

1 ... 24 contacts

IP55 (front)

Four hole front mounting 104 × 104 mm



Order code structure:

Ordering example: 3 pole ON-OFF Switch 60°, 315A, G-handle:

Type - Switching programme - Mounting form

S825 - 61003 - 002G1

Type	Rated data (IEC 60947)			Terminal accessibility
	Operational current I _e AC-21A (A)	Operational power (at 380–440V) AC-23A (kW) AC-3 (kW)		
S825	315	132	55	 Terminals accessible laterally

Detailed technical data page 192.

Switching progr.	Stages	Contacts	Description
61191	1	1	ON-OFF Switch 90°, 1 pole
61192	1	2	ON-OFF Switch 90°, 2 pole
61001	1	1	ON-OFF Switch 60°, 1 pole
61002	1	2	ON-OFF Switch 60°, 2 pole
61003	2	3	ON-OFF Switch 60°, 3 pole
61025	1	2	Changeover Switch with centre OFF 60°, 1 pole
61026	2	4	Changeover Switch with centre OFF 60°, 2 pole
61027	3	6	Changeover Switch with centre OFF 60°, 3 pole
61037	1	2	Changeover Switch without OFF 60°, 1 pole
61038	2	4	Changeover Switch without OFF 60°, 2 pole
61050	2	4	Multi-step Switch without OFF, 4 steps, 1 pole

Switching diagrams and further switching programmes page 156.

Mounting form	Operator
002G1	 G-handle silver/black

Dimensions in mm:

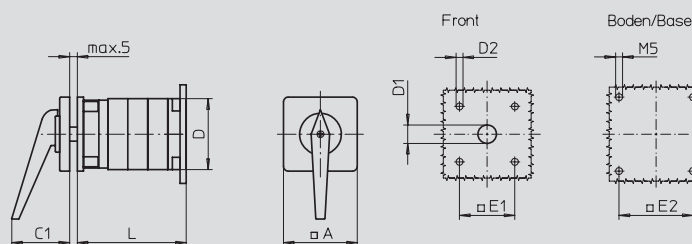

Type	A	C1	D*	D1	D2	E1	E2	L with ... stages (max. 12)						each additional
								1	2	3	4	5	6	
S825	130	74	210	20	5.5	104	104	96	132	168	204	240	276	36

* terminal lugs included

Changeover Switch ■ ON-OFF Switch ■
 Motor Switch ■ Multi-step Switch ■

1 ... 24 contacts

IP55 (front)

Four hole front mounting 104 x 104 mm



Order code structure: **Type** - **Switching programme** - **Mounting form**
 Ordering example: 3 pole ON-OFF Switch 60°, 315A, G-handle: **S825 - 61003 - 041G1**

Type	Rated data (IEC 60947)			Terminal accessibility
	Operational current I _e AC-21A (A)	Operational power (at 380–440V) AC-23A (kW) AC-3 (kW)		
S825	315	132	55	Terminals accessible laterally

Detailed technical data page 192.

Switching progr.	Stages	Contacts	Description
61191	1	1	ON-OFF Switch 90°, 1 pole
61192	1	2	ON-OFF Switch 90°, 2 pole
61001	1	1	ON-OFF Switch 60°, 1 pole
61002	1	2	ON-OFF Switch 60°, 2 pole
61003	2	3	ON-OFF Switch 60°, 3 pole
61025	1	2	Changeover Switch with centre OFF 60°, 1 pole
61026	2	4	Changeover Switch with centre OFF 60°, 2 pole
61027	3	6	Changeover Switch with centre OFF 60°, 3 pole
61037	1	2	Changeover Switch without OFF 60°, 1 pole
61038	2	4	Changeover Switch without OFF 60°, 2 pole
61050	2	4	Multi-step Switch without OFF, 4 steps, 1 pole

Switching diagrams and further switching programmes page 156.

Mounting form	Operator
041G1	G-handle silver/black

Dimensions in mm:

Type	A	C _{min}	C _{max}	C1	D*	D1	D2	E1	E2	L with ... stages (max. 12)			each additional
										1	2	3	
S825	130	75	102	74	210	20	5.5	104	104	90	126	162	36

* terminal lugs included

Four hole mounting 104 × 104 mm

Door interlock

315A

- ON-OFF Switch ■ Changeover Switch
- Multi-step Switch ■ Motor Switch

1 ... 24 contacts

IP55 (front)

Four hole front mounting 104 × 104 mm



Order code structure: **Type** - **Switching programme** - **Mounting form**
 Ordering example: 3 pole ON-OFF Switch 60°, 315A, G-handle: **S825 - 61003 - 042G1**

Type	Rated data (IEC 60947)			Terminal accessibility
	Operational current I _e AC-21A (A)	Operational power (at 380–440V) AC-23A (kW) AC-3 (kW)		
S825	315	132	55	Terminals accessible laterally

Detailed technical data page 192.

Switching progr.	Stages	Contacts	Description
61191	1	1	ON-OFF Switch 90°, 1 pole
61192	1	2	ON-OFF Switch 90°, 2 pole
61001	1	1	ON-OFF Switch 60°, 1 pole
61002	1	2	ON-OFF Switch 60°, 2 pole
61003	2	3	ON-OFF Switch 60°, 3 pole
61025	1	2	Changeover Switch with centre OFF 60°, 1 pole
61026	2	4	Changeover Switch with centre OFF 60°, 2 pole
61027	3	6	Changeover Switch with centre OFF 60°, 3 pole
61037	1	2	Changeover Switch without OFF 60°, 1 pole
61038	2	4	Changeover Switch without OFF 60°, 2 pole
61050	2	4	Multi-step Switch without OFF, 4 steps, 1 pole

Switching diagrams and further switching programmes page 156.

Mounting form	Operator
042G1	G-handle silver/black

Dimensions in mm:

Type	A	C _{min}	C _{max}	C1	D*	D1	D2	E1	E2	L with ... stages (max. 12)			each additional
										1	2	3	
S825	130	75	102	74	210	20	5.5	104	104	90	126	162	36

* terminal lugs included

Insulated enclosure

68 × 68 × 53 mm

20 A



- Instrument Switch ■
- Changeover Switch ■
- Motor Switch ■
- Control Switch ■
- ON-OFF Switch ■
- Multi-step Switch ■

1 ... 4 contacts

IP65

Insulated polycarbonate enclosure

Order code structure:

Ordering example: 2 pole ON-OFF Switch 60°, 20A, N-handle:

Type - Switching programme - Mounting form

M220 - 61002 - 107M1

Type	Rated data (IEC 60947)			Terminal accessibility
	Operational current I _e AC-21A (A)	Operational power (at 380–440V) AC-23A (kW) AC-3 (kW)		
M220	20	7.5	5.5	Terminals accessible laterally

Detailed technical data page 192.

Switching progr.	Stages	Contacts	Description
61191	1	1	ON-OFF Switch 90°, 1 pole
61192	1	2	ON-OFF Switch 90°, 2 pole
61199	2	3	ON-OFF Switch 90°, 3 pole
61194	2	4	ON-OFF Switch 90°, 4 pole, 1 pole early make/late break
61001	1	1	ON-OFF Switch 60°, 1 pole
61002	1	2	ON-OFF Switch 60°, 2 pole
61003	2	3	ON-OFF Switch 60°, 3 pole
61025	1	2	Changeover Switch with centre OFF 60°, 1 pole
61026	2	4	Changeover Switch with centre OFF 60°, 2 pole
61037	1	2	Changeover Switch without OFF 60°, 1 pole
61050	2	4	Multi-step Switch without OFF, 4 steps, 1 pole
61210	2	4	Motor Reversing Switch, 2 pole

Switching diagrams and further switching programmes page 156.

Mounting form	Operator
107M1	M-handle silver/black

Dimensions in mm:

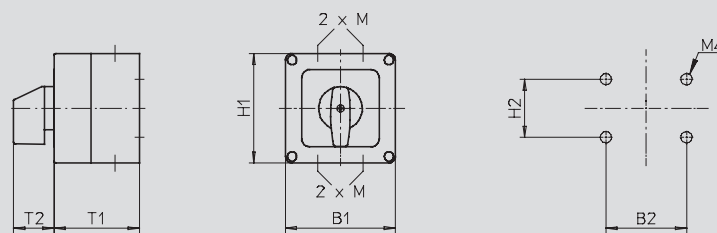

Type	H1	B1	T1	T2	2×M	H2	B2
M220	68	68	53	25	16	36	50

Insulated enclosure

68 × 68 × 53 mm

20A

- Main/Emergency-Off Switch
- Main Switch

1 ... 4 contacts

IP65

Insulated polycarbonate enclosure



Order code structure:

Ordering example: 2 pole Main Switch 90°, 20A, M-handle:

Type - Switching programme - Mounting form

M220 - 61192 - 117M1

Type	Rated data (IEC 60947)			Terminal accessibility
	Operational current I _e AC-21A (A)	Operational power (at 380–440V) AC-23A (kW) AC-3 (kW)		
M220	20	7.5	5.5	Terminals accessible laterally

Detailed technical data page 192.

Switching progr.	Stages	Contacts	Description
61191	1	1	ON-OFF Switch 90°, 1 pole
61192	1	2	ON-OFF Switch 90°, 2 pole
61199	2	3	ON-OFF Switch 90°, 3 pole
61194	2	4	ON-OFF Switch 90°, 4 pole, 1 pole early make/late break

Switching diagrams and further switching programmes page 156.

Mounting form	Operator	Main/Emergency-Off Switch	Mounting form	Operator	Main Switch
117M4		M-padlock device yellow/red	117M1		M-padlock device black

Dimensions in mm:

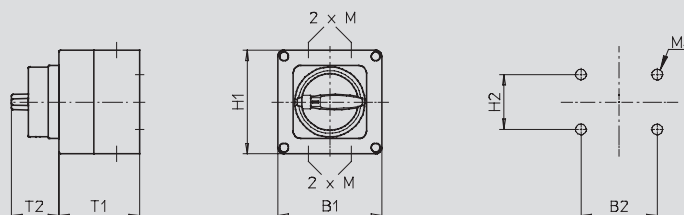

Type	H1	B1	T1	T2	2xM	H2	B2
M220	68	68	53	31	16	36	50

Insulated enclosure

100 × 80 × 65 mm

20 A



- Instrument Switch ■
- Changeover Switch ■
- Motor Switch ■
- Control Switch ■
- ON-OFF Switch ■
- Multi-step Switch ■

1 ... max. 4 contacts

IP66

Insulated polycarbonate enclosure

Order code structure:

Ordering example: 3 pole ON-OFF Switch 60°, 20A, M-handle:

Type - Switching programme - Mounting form

M220 - 61003 - 076M1

Type	contacts:	Rated data (IEC 60947)			Terminal accessibility
		Operational current I _e AC-21A (A)	Operational power (at 380–440V) AC-23A (kW) AC-3 (kW)		
P220	1 ... 2	20	7.5	5.5	Terminals accessible from mounting direction
M220	1 ... 4	20	7.5	5.5	Terminals accessible laterally

Detailed technical data page 192.

Switching progr.	Stages	Contacts	Description	Switching progr.	Stages	Contacts	Description
Type P220:				Type M220:			
61191	1	1	ON-OFF Switch 90°, 1 pole	61003	2	3	ON-OFF Switch 60°, 3 pole
61192	1	2	ON-OFF Switch 90°, 2 pole	61026	2	4	Changeover Switch with centre OFF 60°, 2 pole
61001	1	1	ON-OFF Switch 60°, 1 pole	61038	2	4	Changeover Switch without OFF 60°, 2 pole
61002	1	2	ON-OFF Switch 60°, 2 pole	61049	2	3	Multi-step Switch without OFF, 3 steps, 1 pole
61025	1	2	Changeover Switch with centre OFF 60°, 1 pole	61050	2	4	Multi-step Switch without OFF, 4 steps, 1 pole
61037	1	2	Changeover Switch without OFF 60°, 1 pole	61210	2	4	Motor Reversing Switch, 2 pole

Switching diagrams and further switching programmes page 156.

Mounting form	Operator
076M1	M-handle silver/black

Dimensions in mm:

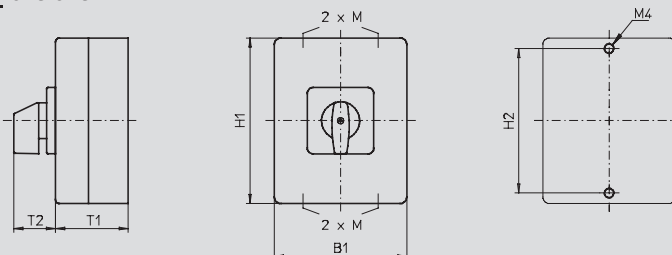

Type	H1	B1	T1	T2	2×M	H2
P220 / M220	100	80	65	32	20	90

Insulated enclosure

100 × 80 × 65 mm

20 A

- Control Switch
- ON-OFF Switch
- Multi-step Switch
- Instrument Switch
- Changeover Switch
- Motor Switch

1 ... max. 4 contacts

IP66

Insulated polycarbonate enclosure



Order code structure:

Ordering example: 2 pole Changeover Switch 90°, 20A, V-handle:

Type - Switching programme - Mounting form

M220 - 61152 - 076V1

Type	contacts:	Rated data (IEC 60947)			Terminal accessibility
		Operational current I _e AC-21A (A)	Operational power (at 380–440V) AC-23A (kW) AC-3 (kW)		
P220	1 ... 2	20	7.5	5.5	Terminals accessible from mounting direction
M220	1 ... 4	20	7.5	5.5	Terminals accessible laterally

Detailed technical data page 192.

Switching progr.	Stages	Contacts	Description	Switching progr.	Stages	Contacts	Description
Type P220:				Type M220:			
61001	1	1	ON-OFF Switch 60°, 1 pole	61003	2	3	ON-OFF Switch 60°, 3 pole
61002	1	2	ON-OFF Switch 60°, 2 pole	61026	2	4	Changeover Switch with centre OFF 60°, 2 pole
61025	1	2	Changeover Switch with centre OFF 60°, 1 pole	61151	1	2	Changeover Switch with centre OFF 90°, 1 pole
61151	1	2	Changeover Switch with centre OFF 90°, 1 pole	61152	2	4	Changeover Switch with centre OFF 90°, 2 pole
				61210	2	4	Motor Reversing Switch, 2 pole

Switching diagrams and further switching programmes page 156.

Mounting form	Operator	Padlockable options
076V1	padlockable with V-handle silver/black	padlockable 12h
078V1	padlockable with V-handle silver/black	3 positions padlockable (09h/12h/03h) (only for Changeover Switches with 90° switching angle)

Dimensions in mm:

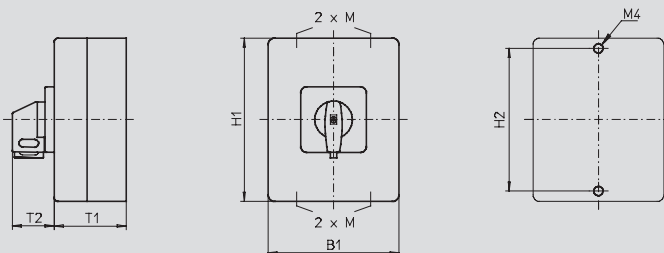

Type	H1	B1	T1	T2	2×M	H2
P220/M220	100	80	65	32	20	90

Main/Emergency-Off Switch ■
Main Switch ■

1 ... max. 4 contacts

Insulated polycarbonate enclosure

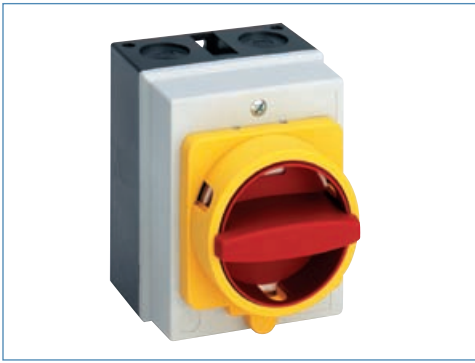

Order code structure:

Ordering example: 2 pole Main Switch 90°, 20A, padlockable with V-handle:

Type - Switching programme - Mounting form

P220 - 61192 - 077V1

Type	contacts:	Rated data (IEC 60947)			Terminal accessibility
		Operational current I _e AC-21A (A)	Operational power (at 380–440V) AC-23A (kW) AC-3 (kW)		
P220	1 ... 2	20	7.5	5.5	Terminals accessible from mounting direction
M220	1 ... 4	20	7.5	5.5	Terminals accessible laterally

Detailed technical data page 192.

Switching progr.	Stages	Contacts	Description	Switching progr.	Stages	Contacts	Description
Type P220:				Type M220:			
61191	1	1	ON-OFF Switch 90°, 1 pole	61191	1	1	ON-OFF Switch 90°, 1 pole
61192	1	2	ON-OFF Switch 90°, 2 pole	61192	1	2	ON-OFF Switch 90°, 2 pole
				61199	2	3	ON-OFF Switch 90°, 3 pole
				61194	2	4	ON-OFF Switch 90°, 4 pole, 1 pole early make/late break

Switching diagrams and further switching programmes page 156.

Mounting form	Operator	Main/Emergency-Off Switch	Mounting form	Operator	Main Switch
077N4		N-padlock device yellow/red	077N1		N-padlock device black
077M4		M-padlock device yellow/red	077M1		M-padlock device black
077V4		padlockable with V-handle yellow/red	077V1		padlockable with V-handle silver/black

Dimensions in mm:

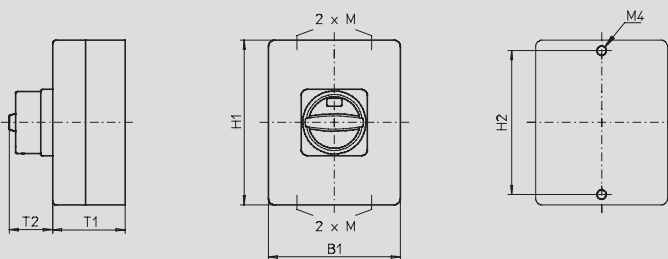

Mounting form	H1	B1	T1	T2	2xM	H2
077N4/077N1	100	80	65	33	20	90
077M4/077M1	100	80	65	38	20	90
077V4/077V1	100	80	65	32	20	90

Insulated enclosure

100 × 80 × 85 mm

20 A

- Control Switch
- ON-OFF Switch
- Multi-step Switch
- Instrument Switch
- Changeover Switch
- Motor Switch

3 ... max. 8 contacts

IP66

Insulated polycarbonate enclosure



Order code structure:

Ordering example: 3 pole Motor Reversing Switch, 20A, M-handle:

Type - Switching programme - Mounting form

M220 - 61211 - 176M1

Type	contacts:	Rated data (IEC 60947)			Terminal accessibility
		Operational current I _e AC-21A (A)	Operational power (at 380–440V) AC-23A (kW) AC-3 (kW)		
P220	3 ... 6	20	7.5	5.5	Terminals accessible from mounting direction
M220	5 ... 8	20	7.5	5.5	Terminals accessible laterally

Detailed technical data page 192.

Switching progr.	Stages	Contacts	Description	Switching progr.	Stages	Contacts	Description
Type P220:				Type M220:			
61199	2	3	ON-OFF Switch 90°, 3 pole	61906	3	6	ON-OFF Switch 90°, 6 pole
61194	2	4	ON-OFF Switch 90°, 4 pole 1 pole early make/late break	61919	4	8	ON-OFF Switch 90°, 8 pole 2 pole early make/late break
61026	2	4	Changeover Switch with centre OFF 60°, 2 pole	61028	4	8	Changeover Switch with centre OFF 60°, 4 pole
61038	2	4	Changeover Switch without OFF 60°, 2 pole	61039	3	6	Changeover Switch without OFF 60°, 3 pole
61049	2	3	Multi-step Switch without OFF, 3 steps, 1 pole	61040	4	8	Changeover Switch without OFF 60°, 4 pole
61211	3	5	Motor Reversing Switch, 3 pole	61211	3	5	Motor Reversing Switch, 3 pole

Switching diagrams and further switching programmes page 156.

Mounting form	Operator
176M1	M-handle silver/black

Dimensions in mm:

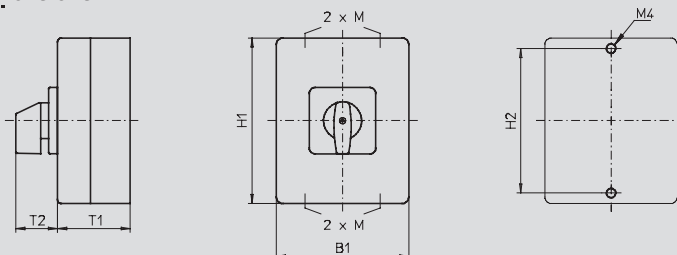

Type	H1	B1	T1	T2	2xM	H2
P220 / M220	100	80	85	32	20	90

Insulated enclosure

100 × 80 × 85 mm

20 A



- Instrument Switch** ■
- Changeover Switch** ■
- Motor Switch** ■
- Control Switch** ■
- ON-OFF Switch** ■
- Multi-step Switch** ■

3... max. 8 contacts

IP66

Insulated polycarbonate enclosure

Order code structure:

Ordering example: 2 pole Changeover Switch 90°, 20A, V-handle:

Type - Switching programme - Mounting form

P220 - 61152 - 178V1

Type	contacts:	Rated data (IEC 60947)			Terminal accessibility
		Operational current I _e AC-21A (A)	Operational power (at 380–440V) AC-23A (kW) AC-3 (kW)		
P220	3 ... 6	20	7.5	5.5	Terminals accessible from mounting direction
M220	5 ... 8	20	7.5	5.5	Terminals accessible laterally

Detailed technical data page 192.

Switching progr.	Stages	Contacts	Description	Switching progr.	Stages	Contacts	Description
Type P220:				Type M220:			
61003	2	3	ON-OFF Switch 60°, 3 pole	61027	3	6	Changeover Switch with centre OFF 60°, 3 pole
61027	3	6	Changeover Switch with centre OFF 60°, 3 pole	61028	4	8	Changeover Switch with centre OFF 60°, 4 pole
61152	2	4	Changeover Switch with centre OFF 90°, 2 pole	61153	3	6	Changeover Switch with centre OFF 90°, 3 pole
61153	3	6	Changeover Switch with centre OFF 90°, 3 pole	61211	3	5	Motor Reversing Switch, 3 pole
61211	3	5	Motor Reversing Switch, 3 pole				

Switching diagrams and further switching programmes page 156.

Mounting form	Operator	Padlockable options
176V1	padlockable with V-handle silver/black	padlockable 12h
178V1	padlockable with V-handle silver/black	3 positions padlockable (09h/12h/03h) (only for Changeover Switches with 90° switching angle)

Dimensions in mm:

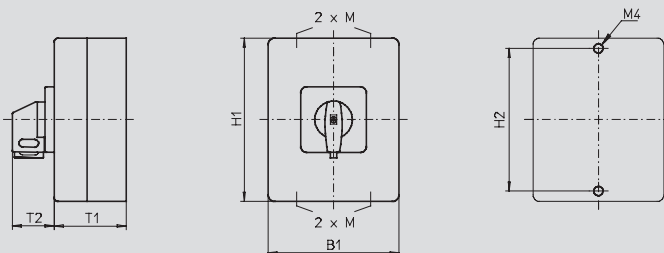

Type	H1	B1	T1	T2	2xM	H2
P220/M220	100	80	85	32	20	90

Insulated enclosure

100 × 80 × 85 mm

Key operated

20 A

- Control Switch
- ON-OFF Switch
- Multi-step Switch
- Instrument Switch
- Changeover Switch
- Motor Switch

1 ... 6 contacts

IP40

Insulated polycarbonate enclosure



Order code structure:

Ordering example: 2 pole ON-OFF Switch 60°, 20A, key operated, key removable at 12h:

Type - Switching programme - Mounting form

M220 - 61002 - E001B

Type	Rated data (IEC 60947)			Terminal accessibility
	Operational current I _e AC-21A (A)	Operational power (at 380–440V) AC-23A (kW) AC-3 (kW)		
M220	20	7.5	5.5	Terminals accessible laterally

Detailed technical data page 192.

Switching progr.	Stages	Contacts	Description
61191	1	1	ON-OFF Switch 90°, 1 pole
61192	1	2	ON-OFF Switch 90°, 2 pole
61001	1	1	ON-OFF Switch 60°, 1 pole
61002	1	2	ON-OFF Switch 60°, 2 pole
61025	1	2	Changeover Switch with centre OFF 60°, 1 pole
61026	2	4	Changeover Switch with centre OFF 60°, 2 pole
61027	3	6	Changeover Switch with centre OFF 60°, 3 pole
61037	1	2	Changeover Switch without OFF 60°, 1 pole
61038	2	4	Changeover Switch without OFF 60°, 2 pole
61049	2	3	Multi-step Switch without OFF, 3 steps, 1 pole
61050	2	4	Multi-step Switch without OFF, 4 steps, 1 pole
61211	3	5	Motor Reversing Switch, 3 pole

Switching diagrams and further switching programmes page 156.

Mounting form	Operator
E001.*	<p>Key operated silver/metal key Ronis cylinder lock C001, 2 keys (other lock types on request)</p> <p>* The dot in the order code number must be replaced by the classification letter which identifies the key removable positions, see page 185.</p>

Dimensions in mm:

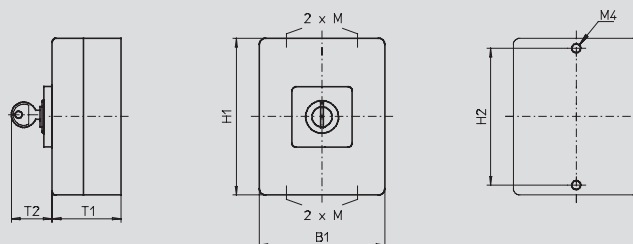

Type	H1	B1	T1	T2	2xM	H2
M220	100	80	85	33	20	90

Main/Emergency-Off Switch ■
Main Switch ■

3 ... max. 8 contacts

Insulated polycarbonate enclosure



Order code structure:

Ordering example: 6 pole ON-OFF Switch 90°, 20A, padlockable with V-handle:

Type - Switching programme - Mounting form

M220 - 61906 - 177V4

Type	contacts:	Rated data (IEC 60947)			Terminal accessibility
		Operational current I _e AC-21A (A)	Operational power (at 380–440V) AC-23A (kW) AC-3 (kW)		
P220	3 ... 6	20	7.5	5.5	Terminals accessible from mounting direction
M220	5 ... 8	20	7.5	5.5	Terminals accessible laterally

Detailed technical data page 192.

Switching progr.	Stages	Contacts	Description	Switching progr.	Stages	Contacts	Description
Type P220:				Type M220:			
61199	2	3	ON-OFF Switch 90°, 3 pole	61906	3	6	ON-OFF Switch 90°, 6 pole
61194	2	4	ON-OFF Switch 90°, 4 pole, 1 pole early make/late break	61919	2	4	ON-OFF Switch 90°, 8 pole, 2 pole early make/late break
61906	3	6	ON-OFF Switch 90°, 6 pole				

Switching diagrams and further switching programmes page 156.

Mounting form	Operator	Main/Emergency-Off Switch	Mounting form	Operator	Main Switch
177N4		N-padlock device yellow/red	177N1		N-padlock device black
177M4		M-padlock device yellow/red	177M1		M-padlock device black
177V4		padlockable with V-handle yellow/red	177V1		padlockable with V-handle silver/black

Dimensions in mm:

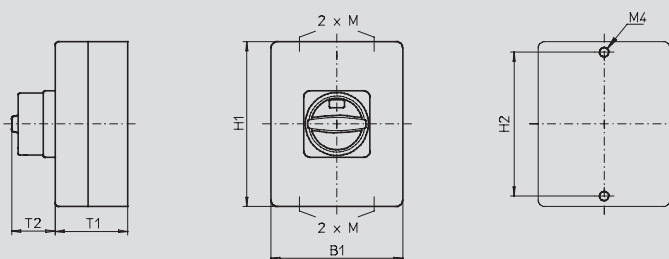

Mounting form	H1	B1	T1	T2	2xM	H2
177N4/177N1	100	80	85	33	20	90
177M4/177M1	100	80	85	38	20	90
177V4/177V1	100	80	85	32	20	90

Switching programmes

ON-OFF Switches 90°

Description	Stages	Contacts	Ident No.	Ident No. with inscription
1 pole	1	1	61191.	
2 pole	1	2	61192.	
3 pole	2	3	61199.	
3 pole with N/PE terminals	2	4	61178.	
3 pole with N terminals	2	4	61908.	
4 pole	2	4	61914.	
4 pole, 1 pole early make/late break	2	4	61194.	
4 pole, 3 pole early make/late break	2	4	61904.	
5 pole, 3 pole early make/late break	3	5	61905.	
6 pole	3	6	61906.	
6 pole, 2 auxiliary contacts	4	8	61907.	
7 pole	4	7	61917.	
8 pole	4	8	61918.	
8 pole, 2 pole early make/late break	4	8	61919.	
9 pole	5	9	61909.	
10 pole	5	10	61910.	
12 pole	6	12	61912.	
Complete rotation				
2 pole	1	2	61198.	
3 pole	2	3	61197.	

ON-OFF Switches 60°

Description	Stages	Contacts	Ident No.	Ident No. with inscription
1 pole	1	1	61001.	
2 pole	1	2	61002.	
3 pole	2	3	61003.	
4 pole	2	4	61004.	
5 pole	3	5	61005.	
6 pole	3	6	61006.	
7 pole	4	7	61007.	
8 pole	4	8	61008.	
9 pole	5	9	61009.	
10 pole	5	10	61010.	
11 pole	6	11	61011.	
12 pole	6	12	61012.	

ON-OFF Switches with spring return

Description	Stages	Contacts	Ident No.	Ident No. with inscription
Spring return to OFF				
1 pole	1	1	61351.	
2 pole	1	2	61352.	
3 pole	2	3	61353.	
4 pole	2	4	61354.	
Spring return to ON				
1 pole	1	1	61302.	61302- 61302A

Switching programmes

Changeover Switches with centre OFF, 60°

Description	Stages	Contacts	Ident No.	Ident No. with inscription
1 pole	1	2	61025.	
2 pole	2	4	61026.	
3 pole	3	6	61027.	
4 pole	4	8	61028.	
5 pole	5	10	61029.	
6 pole	6	12	61030.	
7 pole	7	14	61031.	
8 pole	8	16	61032.	
without jumpers				
1 pole	1	2	61625.	
2 pole	2	4	61626.	
3 pole	3	6	61627.	

Changeover Switches with centre OFF, 90°

Description	Stages	Contacts	Ident No.	Ident No. with inscription
1 pole	1	2	61151.	
2 pole	2	4	61152.	
3 pole	3	6	61153.	
4 pole	4	8	61154.	

Changeover Switches with centre OFF and spring return













Description	Stages	Contacts	Ident No.	Ident No. with inscription
Spring return to centre				
1 pole	1	2	61361.	
2 pole	2	4	61362.	
3 pole	3	6	61363.	
without jumpers				
1 pole	1	2	61761.	
2 pole	2	4	61762.	

Switching programmes







Changeover Switches with centre OFF and spring return

Description	Stages	Contacts	Ident No.	Ident No. with inscription
Spring return from left to centre				
1 pole	1	2	61364.	
2 pole	2	4	61365.	
3 pole	3	6	61369.	
61...-				

Changeover Switches without OFF

Description	Stages	Contacts	Ident No.	Ident No. with inscription
1 pole	1	2	61037.	
2 pole	2	4	61038.	
3 pole	3	6	61039.	
4 pole	4	8	61040.	
5 pole	5	10	61041.	
6 pole	6	12	61042.	
7 pole	7	14	61043.	
8 pole	8	16	61044.	
9 pole	9	18	61045.	
10 pole	10	20	61046.	
11 pole	11	22	61047.	
12 pole	12	24	61048.	
without jumpers				
1 pole	1	2	61637.	
2 pole	2	4	61638.	
3 pole	3	6	61639.	
4 pole	4	8	61640.	
overlapping contacts				
1 pole	1	2	61737.	
2 pole	2	4	61738.	
3 pole	3	6	61739.	
4 pole	4	8	61740.	
without jumpers				
1 pole	1	2	61637.	
2 pole	2	4	61638.	
3 pole	3	6	61639.	
4 pole	4	8	61640.	
overlapping contacts				
1 pole	1	2	61737.	
2 pole	2	4	61738.	
3 pole	3	6	61739.	
4 pole	4	8	61740.	
without jumpers				
1 pole	1	2	61637.	
2 pole	2	4	61638.	
3 pole	3	6	61639.	
4 pole	4	8	61640.	
5 pole	5	10	61041.	
6 pole	6	12	61042.	
7 pole	7	14	61043.	
8 pole	8	16	61044.	
9 pole	9	18	61045.	
10 pole	10	20	61046.	
11 pole	11	22	61047.	
12 pole	12	24	61048.	
without jumpers				
1 pole	1	2	61637.	
2 pole	2	4	61638.	
3 pole	3	6	61639.	
4 pole	4	8	61640.	
overlapping contacts				
1 pole	1	2	61737.	
2 pole	2	4	61738.	
3 pole	3	6	61739.	
4 pole	4	8	61740.	

Changeover Switches without OFF with spring return

Description	Stages	Contacts	Ident No.	Ident No. with inscription
Spring return to left				
1 pole	1	2	61371.	
2 pole	2	4	61372.	
3 pole	3	6	61373.	
without jumpers				
1 pole	1	2	61771.	
2 pole	2	4	61372.	
3 pole	3	6	61373.	
4 pole	4	8	61640.	
5 pole	5	10	61041.	
6 pole	6	12	61042.	
without jumpers				
1 pole	1	2	61771.	
2 pole	2	4	61372.	
3 pole	3	6	61373.	
4 pole	4	8	61640.	
5 pole	5	10	61041.	
6 pole	6	12	61042.	
without jumpers				
1 pole	1	2	61771.	
2 pole	2	4	61372.	
3 pole	3	6	61373.	
4 pole	4	8	61640.	
5 pole	5	10	61041.	
6 pole	6	12	61042.	
without jumpers				
1 pole	1	2	61771.	
2 pole	2	4	61372.	
3 pole	3	6	61373.	
4 pole	4	8	61640.	
5 pole	5	10	61041.	
6 pole	6	12	61042.	
without jumpers				
1 pole	1	2	61771.	
2 pole	2	4	61372.	
3 pole	3	6	61373.	
4 pole	4	8	61640.	
5 pole	5	10	61041.	
6 pole	6	12	61042.	





























Switching programmes

Multi-step Switches with OFF

Description	Stages	Contacts	Ident No.	Ident No. with inscription
2 steps				
1 pole	1	2	61059.	
2 pole	2	4	61079.	
3 pole	3	6	61099.	
4 pole	4	8	61130.	61...- 61...A 61...B
5 pole	5	10	61134.	
6 pole	6	12	61137.	
3 steps				
1 pole	2	3	61060.	
2 pole	3	6	61080.	
3 pole	5	9	61100.	
4 pole	6	12	61131.	61...- 61...A 61...B 61...C 61...D
5 pole	8	15	61135.	
4 steps				
1 pole	2	4	61061.	
2 pole	4	8	61081.	
3 pole	6	12	61101.	
4 pole	8	16	61132.	61...- 61...A
5 steps				
1 pole	3	5	61062.	
2 pole	5	10	61082.	
3 pole	8	15	61102.	61...- 61...A
6 steps				
1 pole	3	6	61063.	
2 pole	6	12	61083.	
3 pole	9	18	61103.	61...- 61...A
7 steps				
1 pole	4	7	61064.	
2 pole	7	14	61084.	
				61...- 61...A
8 steps				
1 pole	4	8	61065.	
				61065- 61065A
9 steps				
1 pole	5	9	61066.	
				61066- 61066A
10 steps				
1 pole	5	10	61067.	
				61067- 61067A
11 steps				
1 pole	6	11	61068.	
				61068- 61068A



Switching programmes

Multi-step Switches without OFF



Description	Stages	Contacts	Ident No.	Ident No. with inscription
3 steps				
1 pole	2	3	61049.	
2 pole	3	6	61069.	
3 pole	5	9	61089.	
4 pole	6	12	61120.	61...- 
5 pole	8	15	61124.	61...A 
6 pole	9	18	61126.	
without jumpers				
1 pole	2	3	61649.	
2 pole	3	6	61669.	
4 steps				
1 pole	2	4	61050.	
2 pole	4	8	61070.	
3 pole	6	12	61090.	
4 pole	8	16	61121.	61...- 
5 pole	10	20	61125.	61...A 
6 pole	12	24	61127.	
without jumpers				
1 pole	2	4	61650.	
2 pole	4	8	61670.	
5 steps				
1 pole	3	5	61051.	
2 pole	5	10	61071.	
3 pole	8	15	61091.	
4 pole	10	20	61122.	61...- 
6 steps				
1 pole	3	6	61052.	
2 pole	6	12	61072.	
3 pole	9	18	61092.	
7 steps				
1 pole	4	7	61053.	
2 pole	7	14	61073.	
3 pole	11	21	61093.	
8 steps				
1 pole	4	8	61054.	
2 pole	8	16	61074.	
3 pole	12	24	61094.	
9 steps				
1 pole	5	9	61055.	
10 steps				
1 pole	5	10	61056.	
11 steps				
1 pole	6	11	61057.	
12 steps				
1 pole	6	12	61058.	

Switching programmes











Code Switches

Description	Stages	Contacts	Ident No.	Ident No. with inscription
Binary code				
0 - 7	2	3	61920.	 61...-
0 - 7 complement	2	3	61921.	
0 - 7 + complement	3	6	61922.	
0 - 11	2	4	61923.	 61...-
0 - 11 + complement	4	8	61924.	
BCD Code				
0 - 9	2	4	61930.	 61...-
0 - 9 complement	2	4	61931.	
0 - 9 + complement	4	8	61932.	

Gang Switches

Description	Stages	Contacts	Ident No.	Ident No. with inscription
2 gangs				
1 pole	1	2	61109.	 61...-
2 pole	2	4	61117.	
3 pole	3	6	61111.	
3 gangs				
1 pole	2	3	61110.	 61...-
2 pole	3	6	61118.	
3 pole	5	9	61112.	
Series-gang Switches				
2 gangs				
1 pole	1	2	61113.	 61...A
2 pole	2	4	61115.	
3 pole	3	6	61114.	
Series-parallel Switches				
2 gangs				
2 pole	2	4	61116.	

Voltmeter Selector Switches with OFF

Description	Stages	Contacts	Ident No.	Ident No. with inscription
3 phase line to line, 30°	2	4	61312.	 61312-  61312A  61312B  61312C  61312D  61312E
				 61312F
3 phase line to line, 60°	2	4	61485.	 61485-  61485A  6485B

Switching programmes

Voltmeter Selector Switches with OFF















Description	Stages	Contacts	Ident No.	Ident No. with inscription
3 phase line to N	2	4	61311.	<p>61311- 61311A 61311B 61311C 61311D 61311E</p>
3 phase line to line + 3 phase line to N	3	6	61313.	<p>61313- 61313A 61313B 61313C 61313D 61313E 61313F 61313G</p>
3 phase line to line + 1 phase line to N	3	5	61317.	<p>61317- 61317A 61317B 61317C 61317D 61317E</p>
3 phase line to line for 2 sources	4	8	61318.	<p>61318- 61318A 61318B 61318C 61318D 61318E 61318F 61318G</p>
2 pole, 1 phase	1	2	61198.	<p>61198- 61198A 61198B 61198C</p>

Voltmeter Selector Switches without OFF





Description	Stages	Contacts	Ident No.	Ident No. with inscription
3 phase line to line	2	4	61319.	<p>61319- 61319A 61319B</p>
3 phase line to line + 3 phase line to N	3	6	61314.	<p>61314- 61314A 61314B</p>

Switching programmes











Ammeter Selector Switches with OFF

Description	Stages	Contacts	Ident No.	Ident No. with inscription
1 transformer, 1 pole	1	2	61321.	     61321- 61321A 61321B 61321C 61321G
2 transformers, 1 pole (3 phase)	2	4	61331.	       61...- 61...A 61...B 61...C 61...D 61...E 61...F
3 transformers, 1 pole	3	6	61325.	
3 transformers, 2 pole	5	9	61328.	
2 transformers, 2 pole	3	6	61327.	   61327- 61327A 61327E

Ammeter Selector Switches without OFF













Description	Stages	Contacts	Ident No.	Ident No. with inscription
3 transformers, 1 pole	3	6	61384.	  61...- 61...A
3 transformers, 2 pole	5	9	61329.	
4 transformers, 1 pole	4	8	61326.	  61...- 61...A
4 transformers, 2 pole	6	12	61330.	

Volt-Ammeter Selector Switches







Description	Stages	Contacts	Ident No.	Ident No. with inscription
1 phase line to line, 2 phase voltages L-N, 2 currents	4	8	61334.	   61334- 61334A 61334B
3 voltages L-L, 3 currents	5	10	61336.	    61...- 61...A 61...B 61...C
3 phase voltages L-N, 3 currents	5	9	61338.	
4 voltages, 3 currents	6	11	61337.	   61337- 61337A 61337B

Switching programmes







Control Switches with spring return

Description	Stages	Contacts	Ident No.	Ident No. with inscription
Control Switches				
1 pole	1	2	61300.	
2 pole	2	4	61388.	
without jumpers				
1 pole	1	2	61700.	
Control Switches with position indication				
1 pole	1	2	61301.	
without jumpers				
1 pole	1	2	61701.	
				
Controlling two contactors				
Standard	2	3	61307.	
without jumpers	2	3	61707.	
				
				61...- 61...A 61...B
With spring return				
4 auxiliary contacts	2	4	61366.	
Motor voltage control switch	2	3	61271.	
single winding contactor	4	8	61272.	
				61...- 61...T

Motor Reversing Switches





Description	Stages	Contacts	Ident No.	Ident No. with inscription
2 pole	2	4	61210.	
3 pole	3	5	61211.	
				
				61...- 61...A 61...B
3 pole with spring return	3	5	61253.	
				
				61253- 61253T
3 pole, complete rotation	3	5	61214.	
				
				61214- 61214A

Star-Delta Switches









Description	Stages	Contacts	Ident No.	Ident No. with inscription
Standard	4	8	61200.	
Contact closed in "OFF"/"STOP"	5	9	61239.	
				
				
				61...- 61...A 61...B 61...C
Spring return from START to "OFF"	4	8	61201.	
				
				61201- 61201A

Switching programmes









Star-Delta Switches

Description	Stages	Contacts	Ident No.	Ident No. with inscription
for use with contactor	4	7	61240.	   61240- 61240A 61240B
Reversing Star-Delta Switches Standard	5	10	61203.	  61203- 61203A

Multi-Speed Switches

Description	Stages	Contacts	Ident No.	Ident No. with inscription
2 speeds single winding	4	8	61212.	 
single winding - contactor control	5	10	61215.	61...- 61...A
2 separate windings	3	6	61219.	
2 speeds single winding	4	8	61213.	  61213- 61213A
3 speeds speed 1+3 Dahlander	6	11	61226.	  61...- 61...A
speed 2+3 Dahlander	6	11	61243.	
Reversing Multi-Speed Switches 2 speeds, single winding	6	12	61217.	   61217- 61217A 61217B

Auxiliary Phase Switches

Description	Stages	Contacts	Ident No.	Ident No. with inscription
Standard	2	3	61208.	    61208- 61208A 61208B 61208C
2 directions	3	6	61209.	   61209- 61209A 61209B
2 directions phase continuously under load	3	6	61270.	  61270- 61270A

Switching diagrams 61001 – 61044

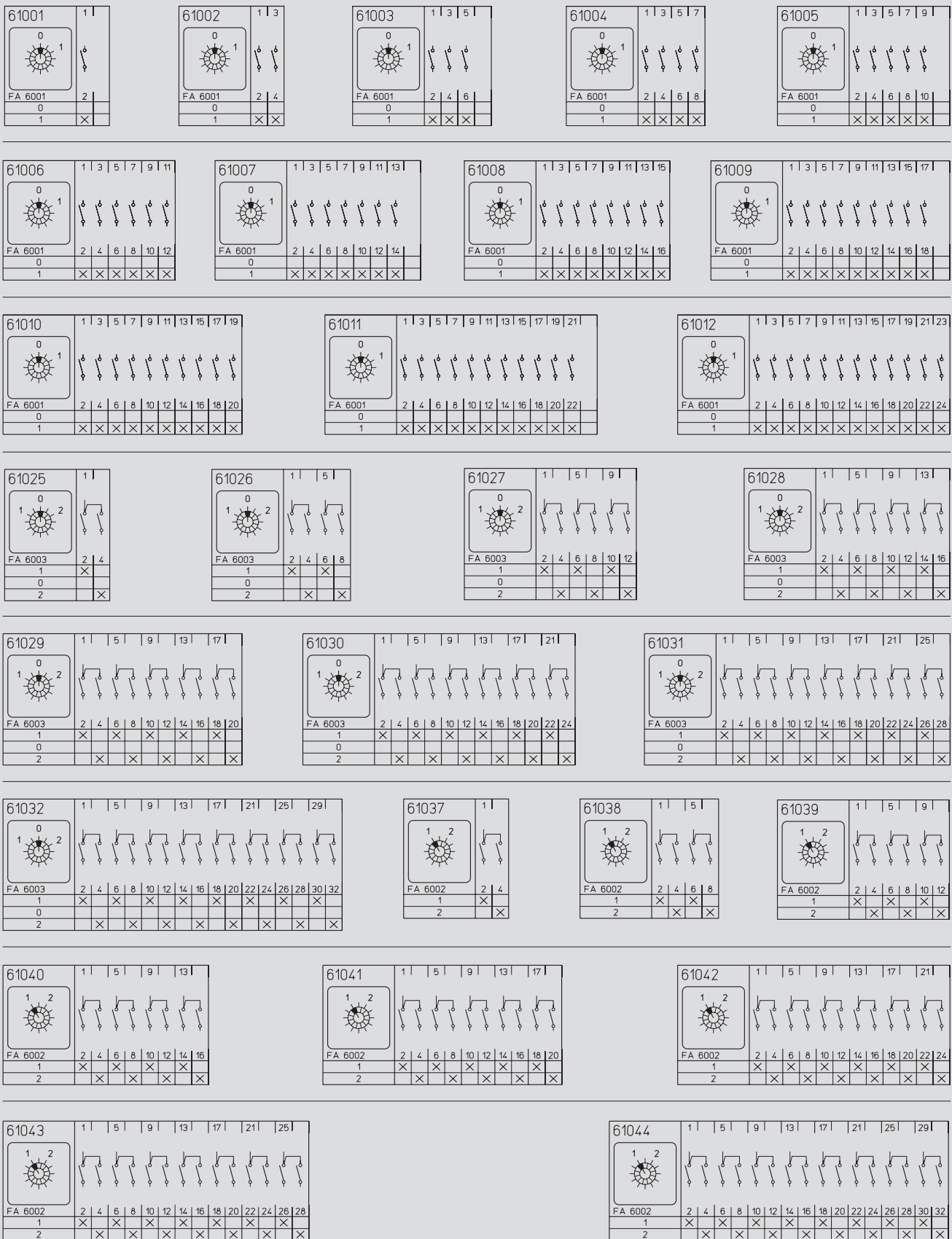

Switching diagrams 61045–61062

61045

FA 6002	2	4	6	8	10	12	14	16	18	20	22	24	26	28	30	32	34	36
1	X	X	X	X	X	X	X	X	X	X	X	X	X	X	X	X	X	X
2	X	X	X	X	X	X	X	X	X	X	X	X	X	X	X	X	X	X

61046

FA 6002	2	4	6	8	10	12	14	16	18	20	22	24	26	28	30	32	34	36	38	40
1	X	X	X	X	X	X	X	X	X	X	X	X	X	X	X	X	X	X	X	
2	X	X	X	X	X	X	X	X	X	X	X	X	X	X	X	X	X	X	X	

61047

FA 6002	2	4	6	8	10	12	14	16	18	20	22	24	26	28	30	32	34	36	38	40	42	44
1	X	X	X	X	X	X	X	X	X	X	X	X	X	X	X	X	X	X	X	X	X	
2	X	X	X	X	X	X	X	X	X	X	X	X	X	X	X	X	X	X	X	X	X	

61048

FA 6002	2	4	6	8	10	12	14	16	18	20	22	24	26	28	30	32	34	36	38	40	42	44	46	48
1	X	X	X	X	X	X	X	X	X	X	X	X	X	X	X	X	X	X	X	X	X	X	X	
2	X	X	X	X	X	X	X	X	X	X	X	X	X	X	X	X	X	X	X	X	X	X	X	

61049

FA 6005	2	4	6
1	X		
2		X	
3			X

61050

FA 6006	2	4	6	8
1	X			
2		X		
3			X	
4				X

61051

FA 6007	2	4	6	8	10
1	X				
2		X			
3			X		
4				X	
5					X

61052

FA 6008	2	4	6	8	10	12
1	X					
2		X				
3			X			
4				X		
5					X	
6						X

61053

FA 3015	2	4	6	8	10	12	14
1	X						
2		X					
3			X				
4				X			
5					X		
6						X	
7							X

61054

FA 3016	2	4	6	8	10	12	14	16
1	X							
2		X						
3			X					
4				X				
5					X			
6						X		
7							X	
8								X

61055

FA 3017	2	4	6	8	10	12	14	16	18
1	X								
2		X							
3			X						
4				X					
5					X				
6						X			
7							X		
8								X	
9									X

61056

FA 3018	2	4	6	8	10	12	14	16	18	20
1	X									
2		X								
3			X							
4				X						
5					X					
6						X				
7							X			
8								X		
9									X	
10										X

61057

FA 3019	2	4	6	8	10	12	14	16	18	20	22
1	X										
2		X									
3			X								
4				X							
5					X						
6						X					
7							X				
8								X			
9									X		
10										X	
11											X

61058

FA 3020	2	4	6	8	10	12	14	16	18	20	22	24
1	X											
2		X										
3			X									
4				X								
5					X							
6						X						
7							X					
8								X				
9									X			
10										X		
11											X	
12												X

61059

FA 6020	2	4
0	X	
1		X
2		

61060

FA 6021	2	4	6
0	X		
1		X	
2			X
3			

61061

FA 6022	2	4	6	8
0	X			
1		X		
2			X	
3				X
4				

61062

FA 6023	2	4	6	8	10
0	X				
1		X			
2			X		
3				X	
4					X
5					

Switching diagrams 61063–61082

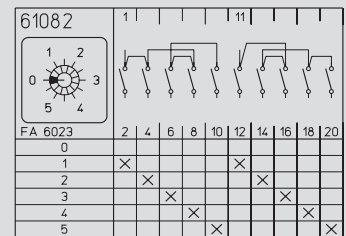
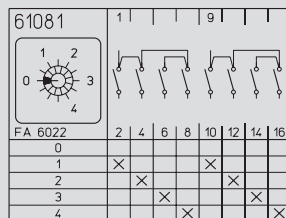
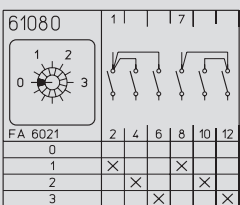
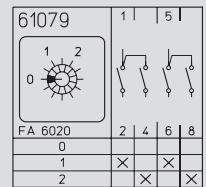
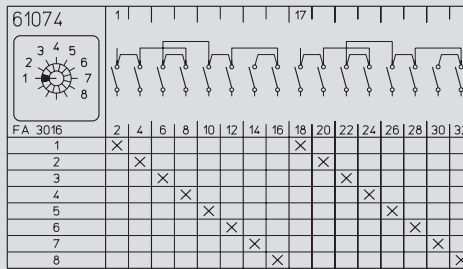
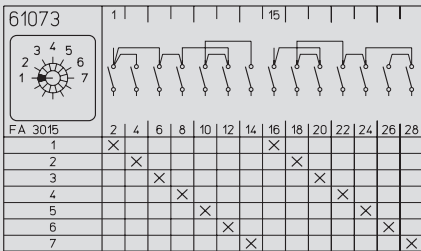
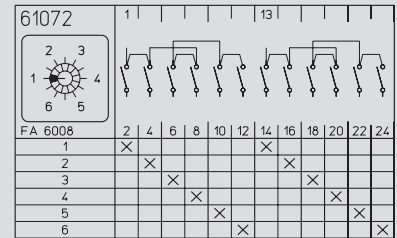
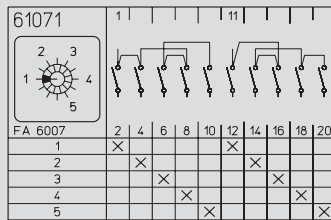
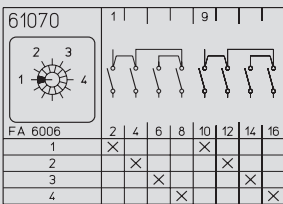
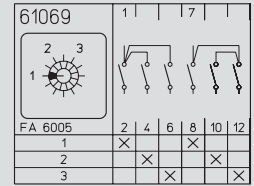
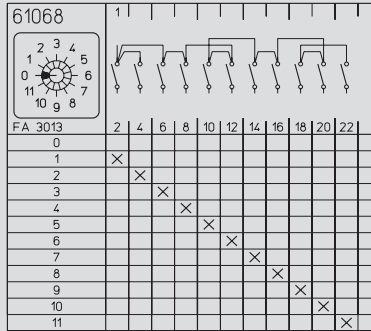
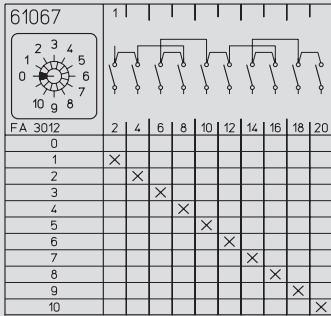
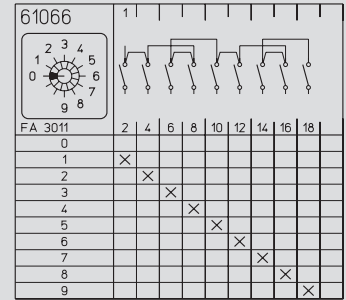
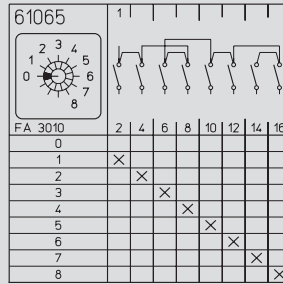
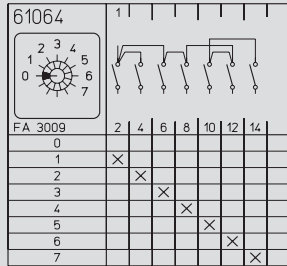
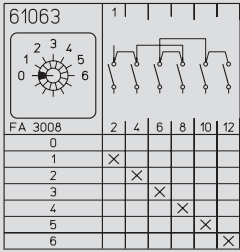

Switching diagrams 61083–61111

61083

FA 3008

	2	4	6	8	10	12	14	16	18	20	22	24
0												
1	X							X				
2		X							X			
3			X							X		
4				X							X	
5					X							X
6						X						

61084

FA 3009

	2	4	6	8	10	12	14	16	18	20	22	24	26	28
0														
1	X								X					
2		X								X				
3			X								X			
4				X								X		
5					X								X	
6						X								X
7							X							

61089

FA 6005

	2	4	6	8	10	12	14	16	18
1	X				X				
2		X				X			X
3			X				X		X

61090

FA 6006

	2	4	6	8	10	12	14	16	18	20	22	24
1	X					X				X		
2		X					X				X	
3			X					X				X
4				X					X			

61091

FA 6007

	2	4	6	8	10	12	14	16	18	20	22	24	26	28	30
1	X					X				X					
2		X					X				X				
3			X					X				X			
4				X					X				X		
5					X					X				X	

61092

FA 6008

	2	4	6	8	10	12	14	16	18	20	22	24	26	28	30	32	34	36
1	X							X					X					
2		X							X					X				
3			X							X					X			
4				X							X					X		
5					X							X					X	
6						X							X					X

61093

FA 3015

	2	4	6	8	10	12	14	16	18	20	22	24	26	28	30	32	34	36	40	42
1	X							X					X			X				
2		X							X					X			X			
3			X							X					X			X		
4				X							X					X			X	
5					X							X					X			X
6						X							X					X		X
7							X							X					X	X

61094

FA 3016

	2	4	6	8	10	12	14	16	18	20	22	24	26	28	30	32	34	36	38	40	42	44	46	48	
1	X								X					X				X							
2		X								X					X				X						
3			X								X					X				X					
4				X								X					X				X				
5					X								X					X				X			
6						X								X					X				X		
7							X								X					X				X	
8								X								X					X				X

61099

FA 6020

	2	4	6	8	10	12
0						
1	X				X	
2		X				X

61100

FA 6021

	2	4	6	8	10	12	14	16	18
0									
1	X				X				
2		X				X			
3			X				X		

61101

FA 6022

	2	4	6	8	10	12	14	16	18	20	22	24
0												
1	X					X				X		
2		X					X				X	
3			X					X				X
4				X					X			

61102

FA 6023

	2	4	6	8	10	12	14	16	18	20	22	24	26	28	30
0															
1	X						X					X			
2		X						X					X		
3			X						X					X	
4				X						X					X
5					X						X				

61103

FA 3008

	2	4	6	8	10	12	14	16	18	20	22	24	26	28	30	32	34	36
0																		
1	X							X					X					
2		X							X					X				
3			X							X					X			
4				X							X					X		
5					X							X					X	
6						X							X					X

61109

FA 6020

	2	4
0		
1	X	
2		X

61110

FA 6021

	2	4	6
0			
1	X		
2		X	
3			X

61111

FA 6020

	2	4	6	8	10	12
0						
1	X				X	
2		X				X
3			X			

Switching diagrams 61112–61137

61112

FA 6021	2	6	8	12	14	20
0						
1	X	X		X		
2	X	X	X	X	X	
3	X	X	X	X	X	X

61113

FA 6021	2	4
0		
1	X	
2		X
3	X	X

61114

FA 6021	2	4	6	8	10	12
0						
1	X	X	X	X		
2	X	X	X	X	X	
3	X	X	X	X	X	X

61115

FA 6021	2	4	6	8
0				
1	X	X		
2	X	X	X	X
3	X	X	X	X

61116

FA 6021	2	4	6
0			
1	X		X
2	X	X	
3	X	X	X

61117

FA 6020	2	4	6	8
0				
1	X	X	X	
2	X	X	X	X

61118

FA 6021	2	4	6	8	10	12
0						
1	X	X	X			
2	X	X	X	X	X	
3	X	X	X	X	X	X

61120

FA 6005	2	4	6	8	10	12	14	16	18	20	22	24
0												
1	X		X		X		X		X		X	
2	X	X		X	X	X		X	X	X		X
3		X		X		X	X		X		X	X

61121

FA 6006	2	4	6	8	10	12	14	16	18	20	22	24	26	28	30	32
0																
1	X				X				X				X			
2		X			X			X		X			X		X	
3		X	X		X	X		X	X	X	X		X	X	X	X

61122

FA 6007	2	4	6	8	10	12	14	16	18	20	22	24	26	28	30	32	34	36	38	40
0																				
1	X				X				X				X				X			
2		X			X			X		X			X		X		X		X	
3		X	X		X	X		X	X	X	X		X	X	X	X	X	X	X	X
4			X		X			X		X			X		X		X		X	X
5			X	X	X	X		X	X	X	X		X	X	X	X	X	X	X	X

61124

FA 6005	2	4	6	8	10	12	14	16	18	20	22	24	26	28	30
0															
1	X		X		X		X		X		X		X		X
2		X		X	X	X		X	X	X		X	X	X	
3		X	X		X	X	X	X	X	X	X	X	X	X	X

61125

FA 6006	2	4	6	8	10	12	14	16	18	20	22	24	26	28	30	32	34	36	38	40
0																				
1	X				X				X				X				X			
2		X			X			X		X			X		X		X		X	
3		X	X		X	X		X	X	X	X		X	X	X	X	X	X	X	X
4			X		X			X		X			X		X		X		X	X

61126

FA 6005	2	4	6	8	10	12	14	16	18	20	22	24	26	28	30	32	34	36
0																		
1	X				X				X				X				X	
2		X			X			X		X			X		X		X	
3		X	X		X	X		X	X	X	X		X	X	X	X	X	X

61127

FA 6006	2	4	6	8	10	12	14	16	18	20	22	24	26	28	30	32	34	36	38	40	42	44	46	48
0																								
1	X				X				X				X				X				X			
2		X			X			X		X			X		X		X		X		X		X	
3		X	X		X	X		X	X	X	X		X	X	X	X	X	X	X	X	X	X	X	X
4			X		X			X		X			X		X		X		X		X		X	X

61130

FA 6020	2	4	6	8	10	12	14	16
0								
1	X	X	X	X	X	X		
2	X	X	X	X	X	X	X	

61131

FA 6021	2	4	6	8	10	12	14	16	18	20	22	24
0												
1	X	X	X	X	X	X	X	X	X	X	X	
2	X	X	X	X	X	X	X	X	X	X	X	X
3	X	X	X	X	X	X	X	X	X	X	X	X

61132

FA 6022	2	4	6	8	10	12	14	16	18	20	22	24	26	28	30	32
0																
1	X				X				X				X			
2	X	X			X	X		X	X	X		X	X	X	X	
3	X	X	X		X	X	X	X	X	X	X	X	X	X	X	X
4	X	X	X	X	X	X	X	X	X	X	X	X	X	X	X	X

61134

FA 6020	2	4	6	8	10	12	14	16	18	20
0										
1	X	X	X	X	X	X	X	X	X	
2	X	X	X	X	X	X	X	X	X	X

61135

FA 6021	2	4	6	8	10	12	14	16	18	20	22	24	26	28	30
0															
1	X	X	X	X	X	X	X	X	X	X	X	X	X	X	
2	X	X	X	X	X	X	X	X	X	X	X	X	X	X	X
3	X	X	X	X	X	X	X	X	X	X	X	X	X	X	X

61137

FA 6020	2	4	6	8	10	12	14	16	18	20	22	24
0												
1	X	X	X	X	X	X	X	X	X	X	X	
2	X	X	X	X	X	X	X	X	X	X	X	X

Switching diagrams 61151 – 61215

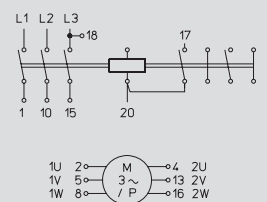
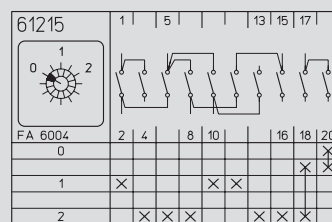
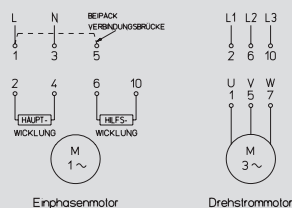
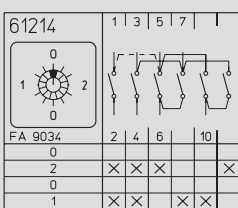
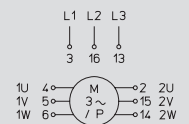
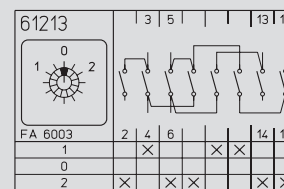
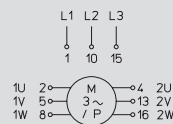
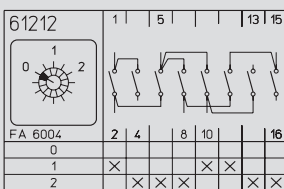
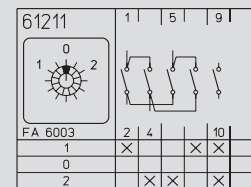
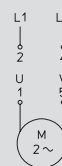
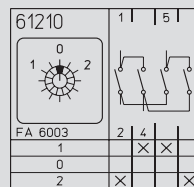
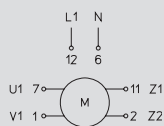
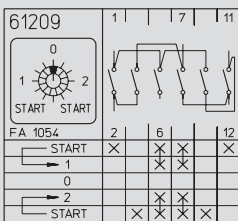
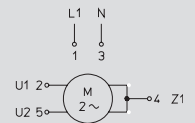
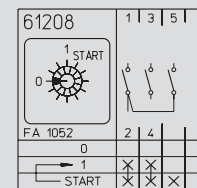
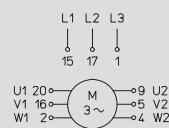
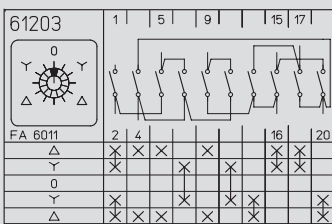
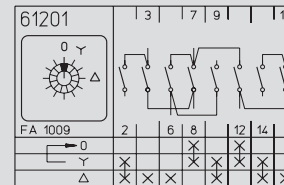
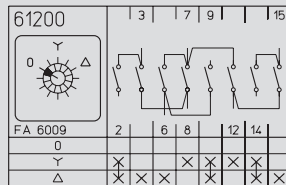
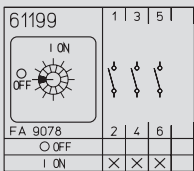
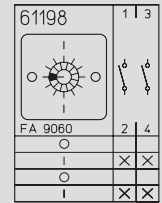
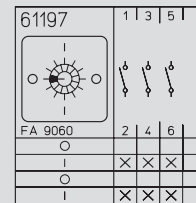
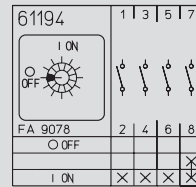
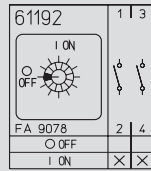
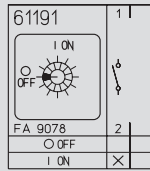
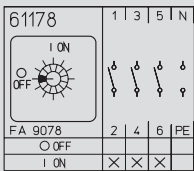
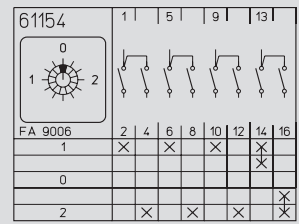
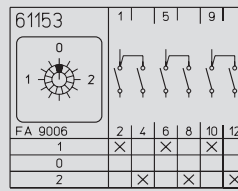
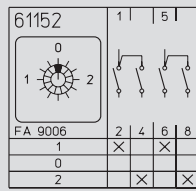
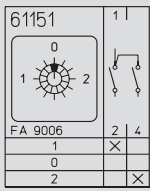

Switching diagrams 61217–61313

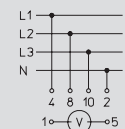
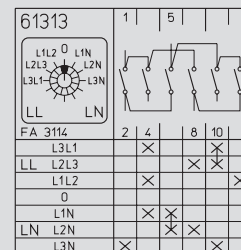
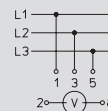
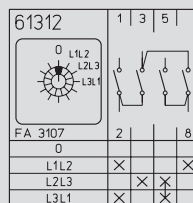
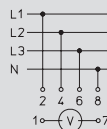
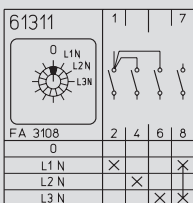
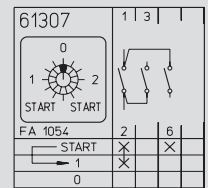
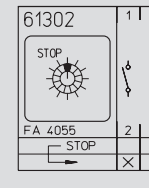
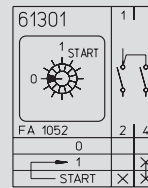
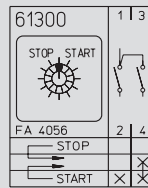
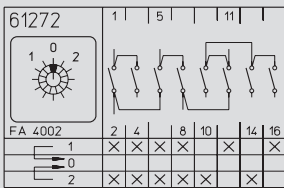
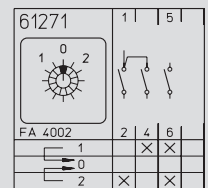
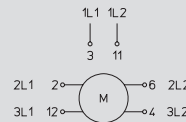
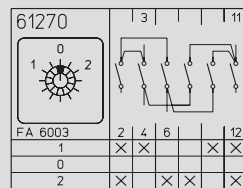
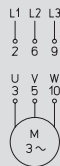
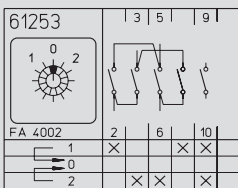
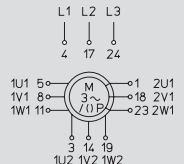
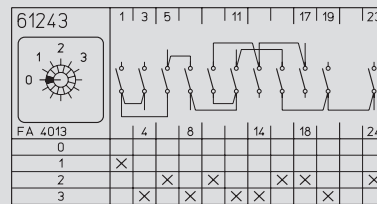
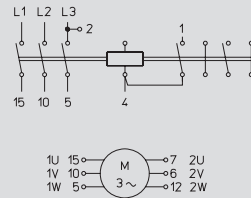
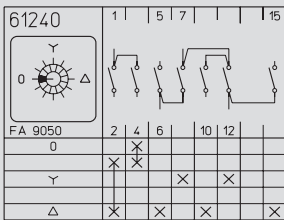
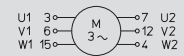
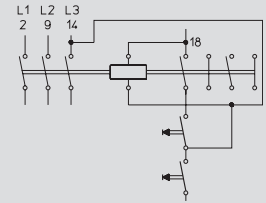
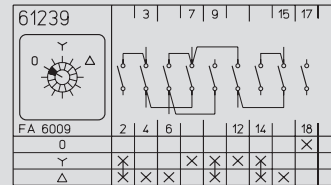
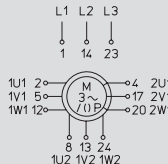
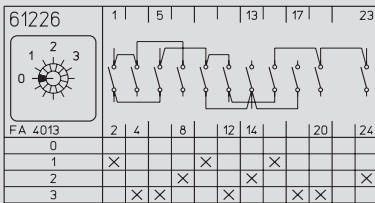
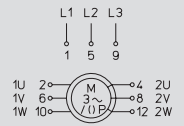
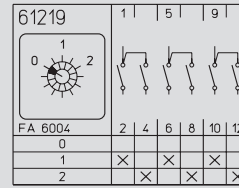
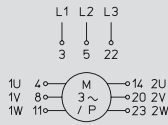
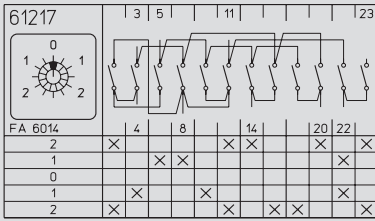

Switching diagrams 61314–61336

61314

FA 3113

L1L2	2	4	8	10	X
L2L3					X
L3L1					X
L1N					X
L2N					X
L3N					X

61317

FA 3111

L1L2	2	4	6	10	X
L3L1					X
L1L2					X
0					X
L1N					X

61318

FA 3115

L1L2	2	4	8	10	14	16	X
L3L1							X
L2L3							X
L1L2							X
0							X
L1L2							X
L2L3							X
L3L1							X

61319

FA 3106

L1L2	2	4	6	X
L2L3				X
L3L1				X

61321

FA 9078

L1L2	2	4	X
L2L3			X
L3L1			X

61325

FA 9010

0	2	8	X
1			X
2			X
3			X

61326

FA 9015

1	2	6	X
2			X
3			X
4			X

61327

FA 9006

0	2	12	X
1			X
2			X

61328

FA 9010

0	2	8	14	16	X
1					X
2					X
3					X

61329

FA 9013

1	2	8	14	16	X
2					X
3					X

61330

FA 9015

1	10	12	14	22	24	X
2						X
3						X
4						X

61331

FA 9010

0	2	6	X
1			X
2			X
3			X

61334

FA 9010

0	2	6	10	12	16	X
1						X
2						X
3						X

61336

FA 9009

0	2	4	10	12	18	X
1						X
2						X
3						X

Switching diagrams 61337–61707

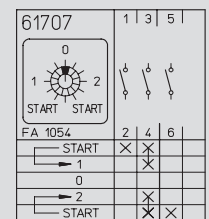
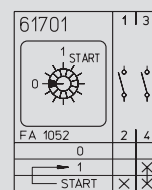
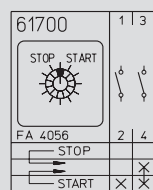
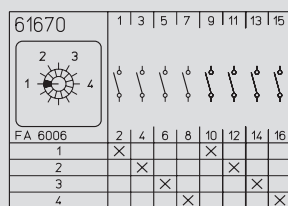
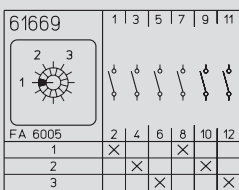
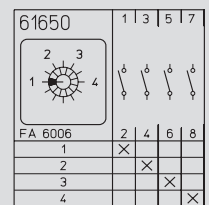
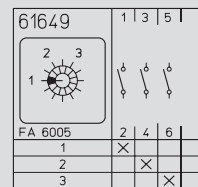
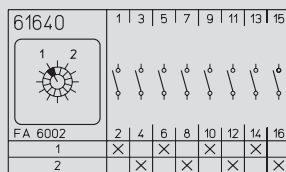
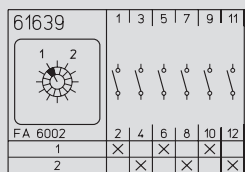
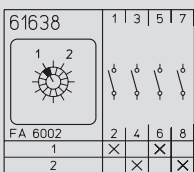
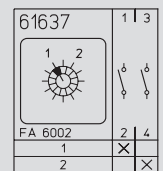
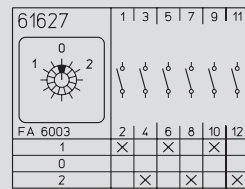
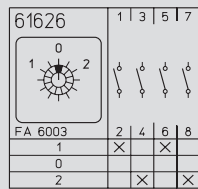
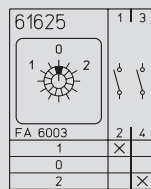
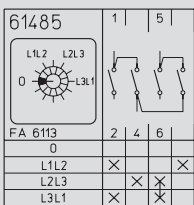
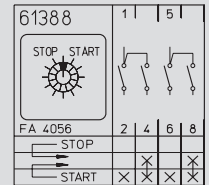
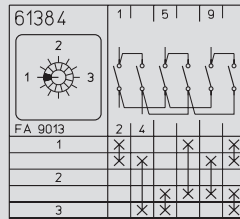
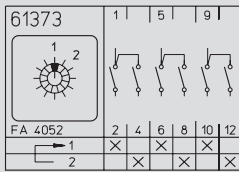
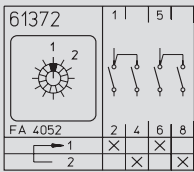
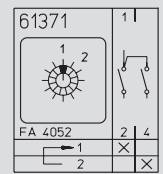
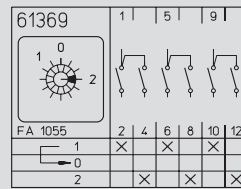
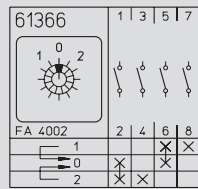
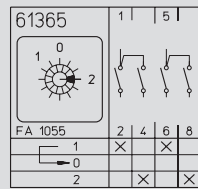
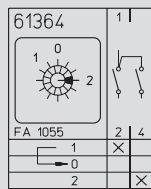
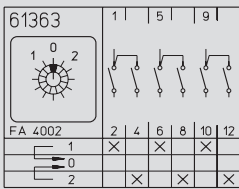
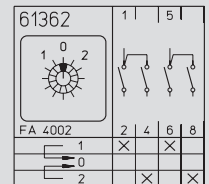
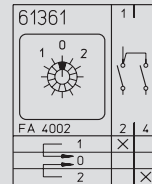
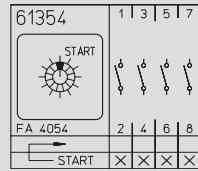
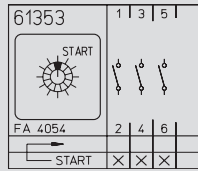
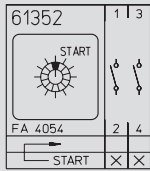
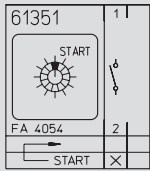
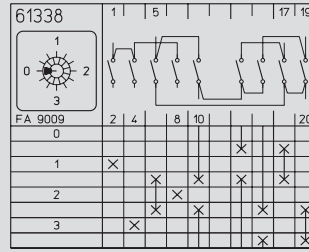
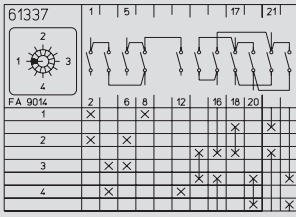

Switching diagrams 61737–61932

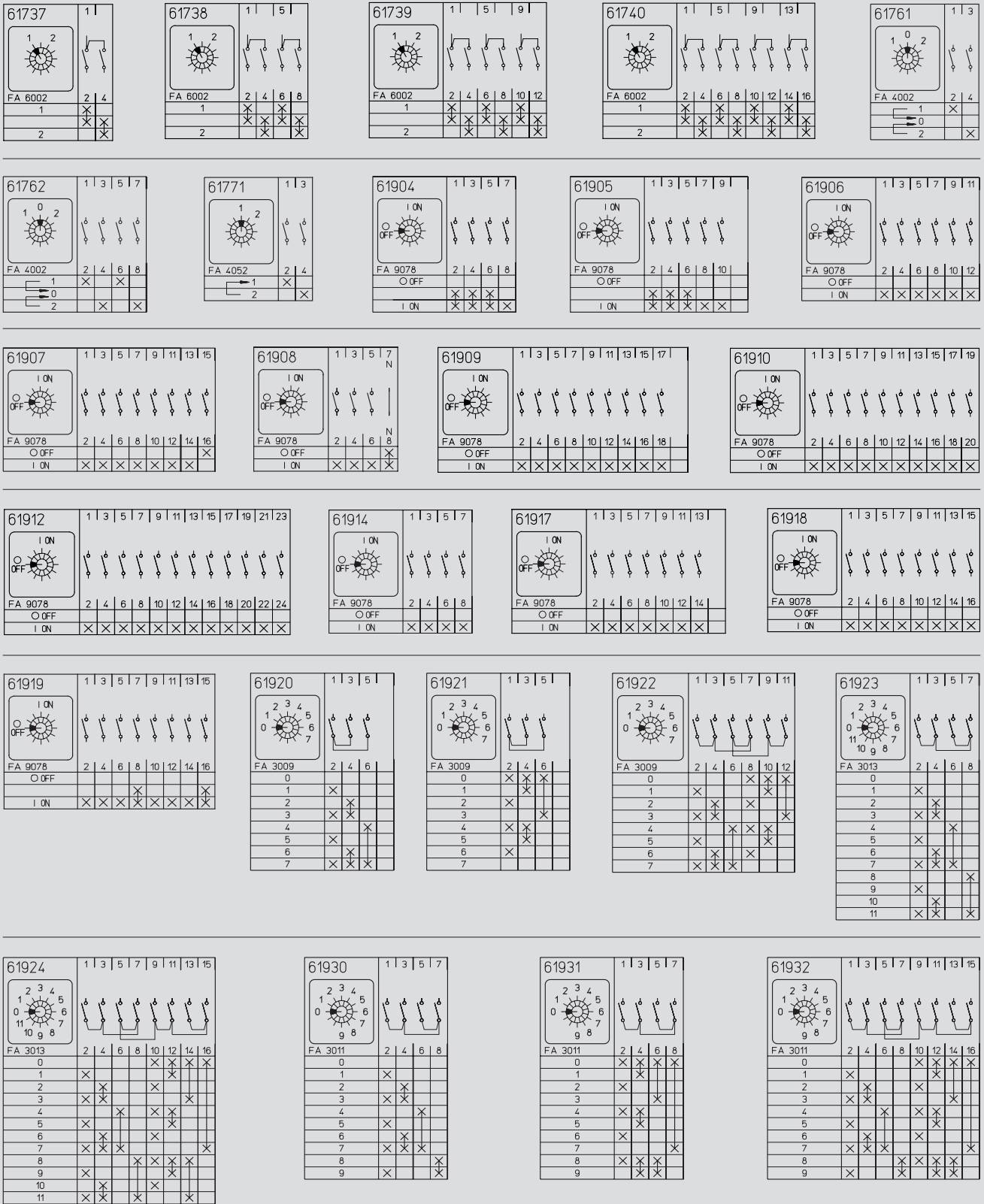

Order form for rotary cam switches with special switching programmes page 188.

Legend plates

2 switch positions

45° switching angle



FA 4018



FA 4020



FA 4022



FA 4047



FA 4048



FA 4052



FA 4054



FA 4055



FA 4056



FA 4066



FA 4073



FA 4077



FA 4078



FA 4080

60° switching angle



FA 6001



FA 6002



FA 6018



FA 6025



FA 6026



FA 6027



FA 6028



FA 6029



FA 6030



FA 6033



FA 6051



FA 6053



FA 6055



FA 6056



FA 6057



FA 6058



FA 6129



FA 6134



FA 6135



FA 6140



FA 6149

90° switching angle



FA 9011



FA 9016



FA 9017



FA 9018



FA 9021



FA 9026



FA 9031



FA 9032



FA 9033



FA 9057



FA 9058



FA 9078



FA 9079



FA 9080

3 switch positions

30° switching angle



FA 3028



FA 3030



FA 3046



FA 3103



FA 3104



FA 3105



FA 3106



FA 3116



FA 3117



FA 3118



FA 3119



FA 3120



FA 3121

Legend plates

3 switch positions

45° switching angle

FA 4001	FA 4002	FA 4006	FA 4012	FA 4024	FA 4025	FA 4026	FA 4027	FA 4028	FA 4029	FA 4030
FA 4031	FA 4032	FA 4033	FA 4034	FA 4035	FA 4036	FA 4037	FA 4038	FA 4045	FA 4067	FA 4068
FA 4069	FA 4070	FA 4071	FA 4072	FA 4074	FA 4076	FA 4079	FA 4081	FA 4082		

60° switching angle

FA 6003	FA 6004	FA 6005	FA 6009	FA 6010	FA 6017	FA 6019	FA 6020	FA 6034	FA 6035	FA 6036
FA 6038	FA 6039	FA 6044	FA 6045	FA 6060	FA 6061	FA 6062	FA 6063	FA 6064	FA 6065	FA 6067
FA 6068	FA 6069	FA 6070	FA 6071	FA 6072	FA 6073	FA 6074	FA 6075	FA 6076	FA 6077	FA 6091
FA 6103	FA 6105	FA 6116	FA 6117	FA 6126	FA 6131	FA 6132	FA 6133	FA 6136	FA 6141	FA 6142
FA 6143	FA 6144	FA 6146	FA 6147	FA 6148	FA 6150	FA 6151	FA 6152			

90° switching angle

FA 9006	FA 9008	FA 9013	FA 9023	FA 9024	FA 9027	FA 9037	FA 9038	FA 9050	FA 9081	FA 9083

Miscellaneous switching angles

FA 1009	FA 1015	FA 1020	FA 1052	FA 1053	FA 1055	FA 1059	FA 1061	FA 1063

Legend plates

4 switch positions

30° switching angle

FA 3014	FA 3021	FA 3022	FA 3029	FA 3047	FA 3056	FA 3058	FA 3087	FA 3088	FA 3089	FA 3090
FA 3107	FA 3108	FA 3109	FA 3110							

45° switching angle

FA 4007	FA 4013	FA 4075	FA 4083	FA 4084	FA 4085

60° switching angle

FA 6006	FA 6013	FA 6021	FA 6041	FA 6049	FA 6104	FA 6113	FA 6114	FA 6119	FA 6127	FA 6137
FA 6138	FA 6145	FA 6153								

90° switching angle

FA 9004	FA 9005	FA 9007	FA 9009	FA 9010	FA 9014	FA 9015	FA 9019	FA 9020	FA 9025	FA 9028
FA 9029	FA 9034	FA 9035	FA 9039	FA 9046	FA 9047	FA 9048	FA 9049	FA 9052	FA 9060	FA 9082
FA 9084										

Miscellaneous switching angles

FA 1017	FA 1022	FA 1056	FA 1057

Legend plates

5 switch positions

30° switching angle



FA 3006



FA 3031



FA 3033



FA 3034



FA 3048



FA 3063



FA 3064



FA 3092



FA 3093



FA 3111



FA 3112

45° switching angle



FA 4003



FA 4008



FA 4014



FA 4039



FA 4040



FA 4041



FA 4059



FA 4060

60° switching angle



FA 6007



FA 6011



FA 6014



FA 6022



FA 6037



FA 6042



FA 6046



FA 6078



FA 6139

Miscellaneous switching angles



FA 1007



FA 1008



FA 1011



FA 1014



FA 1018



FA 1019



FA 1054



FA 1058



FA 1060



FA 1062

6 switch positions

30° switching angle



FA 3007



FA 3032



FA 3049



FA 3100



FA 3113



FA 3122

45° switching angle



FA 4009



FA 4015



FA 4091

Legend plates

6 switch positions

60° switching angle



FA 6008



FA 6012



FA 6015



FA 6023



FA 6024



FA 6040



FA 6043



FA 6047



FA 6081



FA 6083



FA 6085



FA 6098



FA 6118

7 switch positions

30° switching angle



FA 3004



FA 3008



FA 3015



FA 3023



FA 3035



FA 3043



FA 3050



FA 3060



FA 3062



FA 3065



FA 3067



FA 3082



FA 3083



FA 3084



FA 3114



FA 3115

45° switching angle



FA 4004



FA 4010



FA 4016



FA 4086



FA 4087



FA 4088



FA 4089



FA 4090

8 switch positions

30° switching angle



FA 3009



FA 3016



FA 3051

45° switching angle



FA 4011



FA 4017



FA 4046



FA 4058



FA 4061



FA 4092

Legend plates

9 switch positions

30° switching angle



FA 3010



FA 3017



FA 3025



FA 3044



FA 3052

10 switch positions

30° switching angle



FA 3011



FA 3018



FA 3053

11 switch positions

30° switching angle



FA 3012



FA 3019



FA 3054

12 switch positions

30° switching angle



FA 3013



FA 3020



FA 3055



FA 3123

Other



FA 1001

Legend plates

Additional top escutcheon plates

	HAUPTSCHALTER FA 8001	MAIN SWITCH FA 8002	NETZSCHALTER FA 8003	WAHLSCHALTER FA 8004	SELECTOR FA 8005
BETREBSART FA 8006	ISOLATOR FA 8007	GLEISWAHL FA 8008	STEUERUNG FA 8009	FEIN FA 8010	GROB FA 8011
PUMPE FA 8012	NOT-AUS FA 8013	SYNCHRONIZING FA 8014	WATTMETER FA 8015	AMMETER FA 8016	VOLTMETER AMMETER FA 8017
VOLTMETER FA 8018	MOTOR CONTROL FA 8019	HEIZUNG FA 8021	KEUZESCHAKELAAR FA 8023	SCHWEISSEN FA 8024	GLÄTTUNG FA 8025
EMERGENCY OFF FA 8026	TURVAKYTKIN FA 8027	HAUPTSCHALTER NUR IN STELLUNG O OFFENEN FA 8028	MAIN SWITCH OPEN ONLY IN POSITION "OFF" FA 8029	INTERRUPTORE GENERALE ARRRE SOLO CON MANIPOLA SU ZERO FA 8030	INTERRUPTEUR PRINCIPAL OVRN EN POSITION O SEULEMENT FA 8031
VOLTIMETRO FA 8032	AMPERMETRO FA 8033	VATIMETRO FA 8034	CONTROL FA 8035	BOMBA FA 8036	INTERRUPTOR FA 8037
CALEFACCION FA 8038	HOOFDSCHAKELAAR ALLEN IN O-STAND OFFENEN FA 8039	INTERRUPTOR PRINCIPAL ARRR SOLO EN POSICION O FA 8040	HAUPTSCHALTER MAIN SWITCH OFFENEN IN O-STELLUNG OFF-POSITION FA 8041	DANGER ISOLATE MAIN SUPPLY BEFORE REMOVING COVER FA 8042	HUVUDBRYTARE FA 8044
HLAVNÍ VYPÍNAČ FA 8045	HLAVNÍ VYPÍNAČ OTEVŘÍT POUZE V POLOZE O FA 8046	ГЛАВНЫЙ ВЫКЛЮЧАТЕЛЬ открывать только в отключенном положении FA8047			

How to order legend plates

Standard escutcheon 30 x 30 mm

- Legend plate silver, inscription black
- Legend plate yellow, inscription black
- Legend plate black, inscription silver
- Legend plate white, inscription black
- Legend plate black, inscription white

Standard escutcheon 48 x 48 mm

- Legend plate silver, inscription black
- Legend plate yellow, inscription black
- Legend plate black, inscription silver
- Legend plate white, inscription black
- Legend plate black, inscription white

Standard escutcheon 64 x 64 mm

- Legend plate silver, inscription black
- Legend plate yellow, inscription black
- Legend plate black, inscription silver
- Legend plate white, inscription black
- Legend plate black, inscription white

Standard escutcheon 88 x 88 mm

- Legend plate silver, inscription black
- Legend plate yellow, inscription black
- Legend plate black, inscription silver
- Legend plate white, inscription black
- Legend plate black, inscription white

Standard escutcheon 130 x 130 mm

- Legend plate silver, inscription black
- Legend plate yellow, inscription black
- Legend plate black, inscription silver
- Legend plate white, inscription black
- Legend plate black, inscription white

Additional top escutcheon plates

- Legend plate silver, inscription black
- Legend plate yellow, inscription black
- Legend plate black, inscription silver
- Legend plate white, inscription black
- Legend plate black, inscription white

Order code number

- FAS1-.... (+FA number)
- FBS1-.... (+FA number)
- FCS1-.... (+FA number)
- FDS1-.... (+FA number)
- FES1-.... (+FA number)

Order code number

- FAS2-.... (+FA number)
- FBS2-.... (+FA number)
- FCS2-.... (+FA number)
- FDS2-.... (+FA number)
- FES2-.... (+FA number)

Order code number

- FAS4-.... (+FA number)
- FBS4-.... (+FA number)
- FCS4-.... (+FA number)
- FDS4-.... (+FA number)
- FES4-.... (+FA number)

Order code number

- FAS6-.... (+FA number)
- FBS6-.... (+FA number)
- FCS6-.... (+FA number)
- FDS6-.... (+FA number)
- FES6-.... (+FA number)

Order code number

- FAS8-.... (+FA number)
- FBS8-.... (+FA number)
- FCS8-.... (+FA number)
- FDS8-.... (+FA number)
- FES8-.... (+FA number)

Order code number

- FAS2-8... (+FA number)
- FBS2-8... (+FA number)
- FCS2-8... (+FA number)
- FDS2-8... (+FA number)
- FES2-8... (+FA number)

Order form for rotary cam switches with special inscriptions page 190.

Accessories

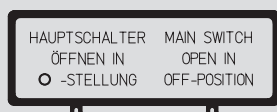

FAZ2-8041

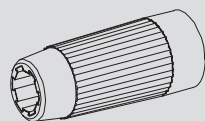

218098

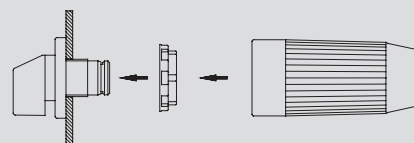

Additional top escutcheon plates

with additional inscription to be clipped on the escutcheons and padlock devices

Order code number

- Escutcheon frame plate black, legend plate silver, without inscription (can be engraved)
- Escutcheon frame plate black, legend plate silver, inscription black, inscription FA 8... (see page 182)
- Escutcheon frame plate black, legend plate silver, inscription black, special engraving
- Escutcheon frame plate black, legend plate yellow, without inscription (can be engraved)
- Escutcheon frame plate black, legend plate yellow, inscription black, inscription FA 8... (see page 182)
- Escutcheon frame plate black, legend plate yellow, inscription black, special engraving
- Escutcheon frame plate black, legend plate black, without inscription (can be engraved)
- Escutcheon frame plate black, legend plate black, inscription silver, inscription FA 8... (see page 182)
- Escutcheon frame plate black, legend plate black, inscription silver, special engraving
- Escutcheon frame plate black, legend plate white, without inscription (can be engraved)
- Escutcheon frame plate black, legend plate white, inscription black, inscription FA 8... (see page 182)
- Escutcheon frame plate black, legend plate white, inscription black, special engraving
- Escutcheon frame plate black, legend plate black, without inscription (can be engraved)
- Escutcheon frame plate black, legend plate black, inscription white, inscription FA 8... (see page 182)
- Escutcheon frame plate black, legend plate black, inscription white, special engraving
- Escutcheon frame plate black (without legend plate)

- FAZ2 - 8000**
- FAZ2 - 8...**
- FAZ2 - (special no.)**
- FBZ2 - 8000**
- FBZ2 - 8**
- FBZ2 - (special no.)**
- FCZ2 - 8000**
- FCZ2 - 8...**
- FCZ2 - (special no.)**
- FDZ2 - 8000**
- FDZ2 - 8...**
- FDZ2 - (special no.)**
- FEZ2 - 8000**
- FEZ2 - 8...**
- FEZ2 - (special no.)**
- FAZ2**

Legend plates for additional top escutcheon plates

- Legend plate silver, without inscription (can be engraved)
- Legend plate silver, inscription black, inscription FA 8... (see page 182)
- Legend plate silver, inscription black, special engraving
- Legend plate yellow, without inscription (can be engraved)
- Legend plate yellow, inscription black, inscription FA 8... (see page 182)
- Legend plate yellow, inscription black, special engraving
- Legend plate black, without inscription (can be engraved)
- Legend plate black, inscription silver, inscription FA 8... (see page 182)
- Legend plate black, inscription silver, special engraving
- Legend plate white, without inscription (can be engraved)
- Legend plate white, inscription black, inscription FA 8... (see page 182)
- Legend plate white, inscription black, special engraving
- Legend plate black, inscription white, inscription FA 8... (see page 182)
- Legend plate black, inscription white, special engraving

- FAS2 - 8000**
- FAS2 - 8...**
- FAS2 - (special no.)**
- FBS2 - 8000**
- FBS2 - 8...**
- FBS2 - (special no.)**
- FCS2 - 8000**
- FCS2 - 8...**
- FCS2 - (special no.)**
- FDS2 - 8000**
- FDS2 - 8...**
- FDS2 - (special no.)**
- FES2 - 8...**
- FES2 - (special no.)**

Assembly tool for single hole mounting

suitable for the fast assembly of escutcheons and padlock devices

Types	Order code number
P110 / P220 / P225 / M220 / M225 / T225	218098

Accessories

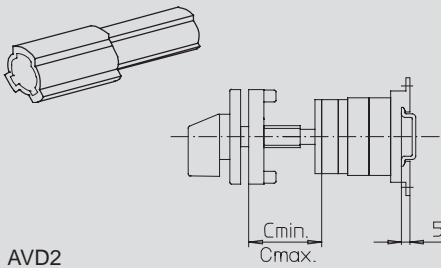

AVD2

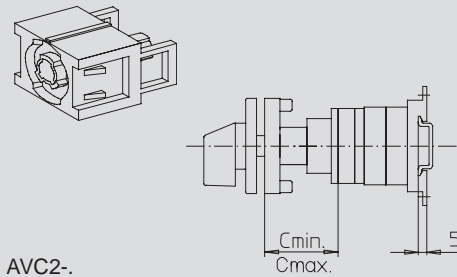

AVC2-

Modular shaft extension for mounting forms with door clutch or door interlock













C_{min}	C_{max}	Number	Order code number	
Door clutch				
42 mm	59 mm	–	–	
60 mm	84 mm	1	AVD2	
85 mm	109 mm	2	AVD2	
110 mm	134 mm	3	AVD2	
135 mm	159 mm	4	AVD2	
160 mm	184 mm	5	AVD2	
185 mm	209 mm	6	AVD2	
Door interlock				
42 mm	57 mm	–	–	
64 mm	82 mm	1	AVC2 - 1	
89 mm	107 mm	1	AVC2 - 2	Please note: AVC2-2 to AVC2-6 have additional parts to aid the stability of the extended shaft modules
114 mm	132 mm	1	AVC2 - 3	
139 mm	157 mm	1	AVC2 - 4	
164 mm	182 mm	1	AVC2 - 5	
189 mm	207 mm	1	AVC2 - 6	

Key removable positions

The dot in the order code number must be replaced by the classification letter which identifies the key removable positions. Due to the construction of the locking cylinder the key can also be removed at 180 degrees of the designated position.



















Type P110

Standard cylinder lock L001. Other lock types on request.

	key removable at 09h/03h		key removable at 01h/07h
	key removable at 12h/06h		key removable at 10h/12h/02h/04h/06h/08h
	key removable at 09h/12h/03h/06h		key removable at 11h/01h/05h/07h
	key removable at 09h/11h/01h/03h/05h/07h		key removable at 10h/12h/04h/06h
	key removable at 10h/04h		key removable at 12h/02h/06h/08h
	key removable at 02h/08h		key removable at 10h/02h/04h/08h
	key removable at 11h/05h		

Types P220 / P225 / M220 / M225 / T225

Standard cylinder lock C001. Other lock types on request.

	key removable at 09h/03h		key removable at 09h/10h/11h/12h/01h/02h/ 03h/04h/05h/06h/07h/08h
	key removable at 12h/06h		key removable at 11h/05h
	key removable at 09h/12h/03h/06h		key removable at 01h/07h
	key removable at 09h/11h/01h/03h/05h/07h		key removable at 10h/12h/02h/04h/06h/08h
	key removable at 10h/04h		key removable at 11h/01h/05h/07h
	key removable at 02h/08h		key removable at 10h/12h/04h/06h
	key removable at 09h/10.30h/12h/01.30h/ 03h/04.30h/06h/07.30h		key removable at 12h/02h/06h/08h
	key removable at 10.30h/04.30h		key removable at 10h/02h/04h/08h
	key removable at 01.30h/07.30h		key removable at 09h/10.30h/03h/04.30h





Operator variants for mounting forms with escutcheon and handle

Operator		Colour escutcheon	Colour legend plate	Colour operator	Change of order code number
M-handle Suitable for product lines P100, M200, P200, T200, S400 and S600		black	silver	black - - ...M1
		grey	silver	grey - - ...M2
		white	silver	white - - ...M3
		black	yellow	red - - ...M4
		black	silver	red - - ...M5
		black	black	black - - ...M8
F-handle Suitable for product lines M200, P200 and T200		black	silver	black - - ...F1
		grey	silver	grey - - ...F2
		white	silver	white - - ...F3
		black	yellow	red - - ...F4
		black	silver	red - - ...F5
		black	black	black - - ...F8
B-handle Suitable for product lines M200, P200, T200, S400, S600 and S800		black	silver	black - - ...B1
		grey	silver	grey - - ...B2
		white	silver	white - - ...B3
		black	yellow	red - - ...B4
		black	silver	red - - ...B5
		black	black	black - - ...B8
N-handle Suitable for product lines M200, P200, T200 and S400		black	silver	black - - ...N1
		grey	silver	grey - - ...N2
		white	silver	white - - ...N3
		black	yellow	red - - ...N4
		black	silver	red - - ...N5
		black	black	black - - ...N8
G-handle Suitable for product lines S400, S600 and S800		black	silver	black - - ...G1
		black	yellow	red - - ...G4
		black	silver	red - - ...G5
		black	black	black - - ...G8
R-handle Suitable for product lines M200, P200, T200 and S400		black	silver	black - - ...R1
		grey	silver	grey - - ...R2
		white	silver	white - - ...R3
		black	yellow	red - - ...R4
		black	silver	red - - ...R5

Installation mounting for 45 mm aperture in Panel/Distribution boards:

M-handle Suitable for product lines M200, P200 and T200		grey	silver	black - - ...M1
		grey	silver	grey - - ...M2
		grey	yellow	red - - ...M4
N-handle Suitable for product lines M200, P200 and T200		grey	silver	black - - ...N1
		grey	silver	grey - - ...N2
		grey	yellow	red - - ...N4

Operator variants for mounting forms with padlock device

Operator		Colour escutcheon	Colour legend plate	Colour operator	Change of order code number
N-padlock device Suitable for product lines M200, P200, T200, S400 and S600		black grey yellow grey yellow	white white white white white	black grey red black black - - ...N1 - - ...N2 - - ...N4 - - ...N6 - - ...N7
M-padlock device Suitable for product lines P100, M200, P200, T200, S400 and S600		black grey yellow grey yellow	white white white white white	black grey red black black - - ...M1 - - ...M2 - - ...M4 - - ...M6 - - ...M7
B-padlock device Suitable for product lines S400, S600 and S800		black black black	silver yellow black	black red black - - ...B1 - - ...B4 - - ...B8
H-padlock device Suitable for product lines S400, S600 and S800		black black black	silver yellow black	black red black - - ...H1 - - ...H4 - - ...H8
Padlockable with V-handle Suitable for product lines P100, M200, P200, T200 and S400		black black	silver yellow	black red - - ...V1 - - ...V4

Installation mounting for 45 mm aperture in Panel/Distribution boards:

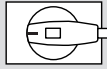
Padlockable with V-handle Suitable for product lines M200, P200 and T200		grey grey	silver yellow	black red - - ...V1 - - ...V4
---	---	--------------	------------------	--------------	--

How to order special switches

Special switching programmes can be produced by means of prefabricated modules either by us or by our authorized workshops all over the world.

For description of the desired course of switching please use our form on page 189. In case of more than 18 contacts an additional form can be used as page 2.

When determining the desired switch the following has to be considered:

- Indicate terminal designations at connection points only and use figures, if possible.
- Mark initial position and/or "OFF" position on the handle with an arrow.
- Mark escutcheon engraving on the escutcheon and indicate it in the column "Switch positions". In the case of special engraving if the space is not sufficient, use the form for special legend plates (refer to page 191) or enclose a sketch.
- Determine the desired switching angle. If necessary due to technical reasons we may suggest a different switching angle.
- The column "locked positions" is to be filled in only in case of interlockings (e.g. key removable position) and locking mechanisms.
- At the bottom of the order form 6 areas are identified (1 to 6). Areas 1 to 3 must always be specified. Areas 4 to 6 have to be completed in case of deviations from the standard equipment of the design and/or upon demand. Area 7 "Order code no." is specified on your first order. For all subsequent orders the indication of this order code number is sufficient.

Ordering example

Bestell-Nr./Order no.		sälzer	
Frontschild/Escutcheon plate 			
Schaltwinkel Switching angle		60°	
Schaltstellungen Switch positions		↓	
<input checked="" type="checkbox"/>	0	1	
		2	
		3	X X
		4	
<input checked="" type="checkbox"/>	1	5	X
		6	
		7	
		8	
<input checked="" type="checkbox"/>	2	9	X
		10	
		11	
		12	
<input checked="" type="checkbox"/>	H	13	X
		14	
		15	
<input checked="" type="checkbox"/>	A	16	
		17	X
		18	X
		19	X
		20	X
		21	
		22	
		23	
		24	
<input checked="" type="checkbox"/> Gesperrte Stellung Locked position		<input checked="" type="checkbox"/> Kontakt geschlossen Contact closed	
		<input checked="" type="checkbox"/> Kontakt über mehrere Stellungen geschlossen Contact closed without interruption	
		<input checked="" type="checkbox"/> Rückzug Spring return	
1) Typ Type	P220	2) Bauform Mounting form	060M1
3) Bedienelemente Operator		4) Zusatzrichtungen Optional extras	5) Anschlag Stop
6) Aufschrift Marking			mit with X
7) Griff Handle			ohne without
	Firma/Company	Datum/Date	Name/Signum

Copy form for special switches

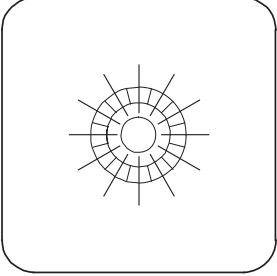
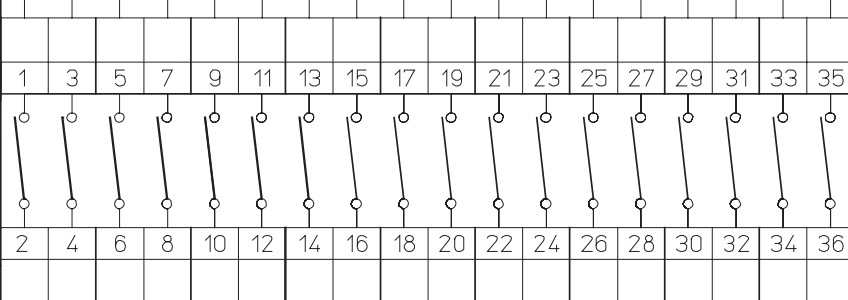
¹ Bestell-Nr./Order no.															
Frontschild/Escutcheon plate 															
Schaltwinkel Switching angle		<input type="checkbox"/>													
Schaltstellungen Switch positions		<input type="checkbox"/>													
0°															
15°															
30°															
45°															
60°															
75°															
90°															
105°															
120°															
135°															
150°															
165°															
180°															
195°															
210°															
225°															
240°															
255°															
270°															
285°															
300°															
315°															
330°															
345°															
¹ ↕ Gesperrte Stellung Locked position		² ✕ Kontakt geschlossen Contact closed				² ✕✕ Kontakt über mehrere Stellungen geschlossen Contact closed without interruption				³ <input type="checkbox"/> Rückzug Spring return					
¹ Typ Type		² Bauform Mounting form				³ Anschlag Stop				mit with		ohne without			
⁴ Bedienelemente Operator		⁶ Zusatzeinrichtungen Optional extras													
⁵ Aufschrift Marking															
				Firma/Company				Datum/Date				Name/Name			

How to order special engravings

For descriptions of the desired special engraving please use our order forms. On page 191 you will find order forms for switches with switching angle 30°/60° and 45°/90°.

When determining the desired engraving the following has to be considered:

- For standard engraving capital letters or figures type Helvetica in black are used.
- Engravings deviating from the standard design like small size text, symbols or graphical symbols please enclose a drawing or a file.
- The max. quantity of letters (symbols) is specified in the order form.
- The max. letter height is for

escutcheon □ 30 mm	=	3.5 mm
escutcheon □ 48 mm	=	4.0 mm
escutcheon □ 64 mm	=	4.5 mm
escutcheon □ 88 mm	=	6.5 mm
escutcheon □ 130 mm	=	8.0 mm

When utilizing the max. letter (symbol) quantity the letter height might be reduced.

- With the first order a **FAX** no. for the legend plate and a **FAZ** no. for the additional legend plate is fixed for every special engraving that will remain valid for all subsequent orders.

Copy form for special engravings

FAX	sälzer	<p>30°/60°</p>	Datum/Date	Name/Signum
FAZ			Firma/Company	

FAX	sälzer	<p>45°/90°</p>	Datum/Date	Name/Signum
FAZ			Firma/Company	

Technical data

General			P110	M220 P220	M221 * P221 *	P225	M225 P226 *	T225	S432	S440	S606	S608	S612	S825		
Standards			IEC 60947, EN 60947, IEC 60204, EN 60204, UL 508, CSA 22.2, No. 14													
Mechanical lifespan Max. operating frequency /h			>10 ⁶ 50	>10 ⁶ 50	>10 ⁶ 50	>10 ⁶ 50	>10 ⁶ 50	>10 ⁶ 50	>10 ⁶ 50	>10 ⁶ 50	>10 ⁶ 50	>10 ⁶ 50	>10 ⁶ 50	>10 ⁶ 50		
Climatic resistance			damp heat, constant, to DIN IEC 60068-2-3 damp heat, cyclic, to DIN IEC 60068-2-30													
Ambient temperature																
open	min/max	°C	-25/+50													
enclosed	min/max	°C	-25/+40													
Mounting position			as required													
Mechanical shock resistance (shock duration 20 ms)			g	>10	>10	>10	>10	>10	>10	>10	>10	>10	>10	>10	>10	
Rated frequency			Hz	50 to 60 (other frequencies on request)												
Rated data																
Operational voltage U _e			V AC	440	690	690	690	690	690	690	690	690	690	690	690	
Impulse withstand voltage U _{imp}			kV	4	6	6	6	6	6	6	6	6	6	6	6	
Overvoltage category				III	III	III	III	III	III	III	III	III	III	III	III	
Pollution degree				3	3	3	3	3	3	3	3	3	3	3	3	
Uninterrupted current I _u /I _{th} /I _{the}			A	10	20	20	25	25	32	50	63	80	100	160	315	
Load carrying capacity in intermittent operation, class 12			AB	60%/40%/25% DF = 1.3/1.6/2 × I _e												
Breaking capacity																
	220–240 V	A	90	180	180	255	255	370	520	550	600	700	900	1800		
	380–440 V	A	70	150	150	230	230	300	430	500	550	600	850	1650		
	500–690 V	A	—	90	90	270	270	210	280	380	420	450	340	350		
Short-circuit rating Max. fuse			gL	10	20	20	25	25	32	50	63	80	100	160	315	
Conditional short-circuit current			kA _{eff}	3	10	10	10	10	15	20	20	25	25	25	25	
Isolating characteristics to EN 60947			up to ...V AC	440	690	690	690	690	690	690	690	690	690	690	690	
Switching angle Contacts (current paths)			max	30°/45°/60°/90° 16 24 24 24 24 24 24 24 24 24 24 24 24 24												
Current heat loss per contact at I _u			W	0.3	0.65	0.65	0.75	0.75	1.0	3.0	3.5	4.0	5.0	11	28.5	
Terminal capacity																
solid or stranded	min	mm ²	0.75	1.0	1.0	1.5	1.5	2.5	2.5	4	6	10	10	185 ¹⁾		
	max	mm ²	1.5	2.5	2.5	4.0	4.0	6.0	10	16	25	35	70	185 ¹⁾		
flexible or multiwire including ferrule	min	mm ²	0.75	1.0	1.0	1.5	1.5	1.5	2.5	2.5	6	10	10	185 ¹⁾		
	max	mm ²	1.5	2.5	2.5	2.5	2.5	4.0	6.0	10	16	25	50	185 ¹⁾		
American Wire Gauge			AWG	16	12	12	10	10	10	6	4	4	1/0	2/0	350MCM	
Thread dimensions for terminal screw				M2.5	M3	M3	M3.5	M3.5	M4	M5	M5	2×M4	2×M5	2×M6	M12	
Terminal tightening torque			min max	Nm Nm	0.4 0.6	0.5 1.0	0.5 1.0	0.8 1.5	0.8 1.5	1.2 2.5	2.0 4.0	2.0 4.0	1.2 2.5	2.0 4.0	2.5 6.0	14 25

* use this version for 600V AC (UL/CSA) applications

¹⁾ with terminal extensions for cable lug connection

Technical data

Rated data			P110	M220 P220	M221 * P221 *	P225	M225 P226 *	T225	S432	S440	S606	S608	S612	S825	
Operational current I _e															
AC-21A		A	10	20	20	25	25	32	50	63	80	100	160	315	
AC-22A	220–500 V	A	10	20	20	25	25	32	50	63	80	100	160	315	
	660–690 V	A	—	20	20	25	25	32	50	63	80	80	125	125	
AC-23A (cos φ=0.65) 400V			A	6	16	16	22	22	30	44	50	65	80	120	285
UL / CSA General Use	300V AC	A	10	20	20	25	25	35	55 ¹⁾	70 ¹⁾	95 ¹⁾	110 ¹⁾	175 ¹⁾	240	
	600V AC	A	—	—	20	—	25	35	55 ¹⁾	70 ¹⁾	95 ¹⁾	110 ¹⁾	175 ¹⁾	240	
Operational power 50–60 Hz, 3 phase															
AC-23A	220–240 V	kW	1.8	4	4	5.5	5.5	7.5	11	15	30	30	37	75	
	380–440 V	kW	3	7.5	7.5	11	11	15	22	30	45	55	75	132	
	500 V	kW	—	7.5	7.5	11	11	15	30	45	55	55	90	132	
	660–690 V	kW	—	7.5	7.5	11	11	15	30	37	45	45	55	55	
AC-3	220–240 V	kW	1.5	3	3	4	4	5.5	11	15	15	22	22	37	
	380–440 V	kW	2.2	5.5	5.5	7.5	7.5	11	22	30	30	37	45	55	
	500 V	kW	—	5.5	5.5	7.5	7.5	11	22	30	30	37	45	55	
	660–690 V	kW	—	5.5	5.5	7.5	7.5	11	22	30	30	37	45	55	
UL / CSA	110–120 V AC	HP	0.5	1	1	1.5	1.5	3	5	7.5	10	10	15	25	
	208 V AC	HP	0.5	2	2	5	5	7.5	7.5	7.5	10	15	15	30	
	220–240 V AC	HP	0.5	2	2	5	5	7.5	10	15	15	15	15	30	
	440–480 V AC	HP	—	—	5	—	10	10	20	30	30	30	40	50	
	550–600 V AC	HP	—	—	5	—	10	10	25	40	50	50	50	50	

Rated data (auxiliary contacts)

Operational voltage U _e		V AC	440	500	500	500	500	500	500	500	500	500	500	500	
Uninterrupted current I _u / I _{th} / I _{the}		A	10	20	20	25	25	32	50	63	80	100	160	315	
Operational current I _e															
AC-21A		A	10	20	20	25	25	32	50	63	80	100	160	315	
AC-15	110–240 V	A	2.5	6	6	6	6	14	16	16	16	16	16	16	
	380–440 V	A	1.5	4	4	5	5	6	7	7	7	7	7	7	
	500 V	A	0.8	2	2	2.5	2.5	3	3.5	3.5	3.5	3.5	3.5	3.5	
UL / CSA General Use		600 V AC	A	—	—	20	—	25	35	55	70	70	110	175	240
Heavy Pilot Duty			B300	A300	A600	A300	A600	A600	A600	A600	A600	A600	A600	A600	
Short-circuit rating Max. fuse		gL	10	20	20	25	25	32	50	63	80	100	160	315	
Conditional short-circuit current		kA _{eff}	3	10	10	10	10	15	20	20	25	25	25	25	
Terminal capacity flexible or multiwire including ferrule		min max	mm ² mm ²	0.75 1.5	1 2.5	1 2.5	1.5 2.5	1.5 2.5	1.5 4.0	2.5 6.0	2.5 10	6 16	10 25	10 50	185 ¹⁾ 185 ¹⁾
American Wire Gauge		AWG	16	12	12	10	10	10	6	4	4	1/0	2/0	350MCM	

Conformity

The Rotary Cam Switches conform to the regulations of the EC guideline 73/23 EEC 'Electrical equipment for application within certain voltage limits' – specified as directive for low voltage devices.

The conformity is proved by the complete compliance of the harmonized European standards

- EN 60947-1
- EN 60947-3
- EN 60947-5-1
- EN 60204-1.

Salzer Electric products are developed, manufactured and tested according to these standards.

The CE marking on all our products prove the conformity to the directives.



The Rotary Cam Switches are approved according to UL 508 and CSA 22.2, No. 14.



* use this version for 600V AC (UL/CSA) applicatons

¹⁾ with terminal extensions for cable lug connection

Utilization Categories

Utilization categories for Switches, Disconnectors, Switch-Disconnectors and Fuse-Combination Units

Type of Current	Utilization Category		Typical applications
	Frequent operation	Occasional operation	
AC	AC-20A *	AC-20B *	Making and breaking without load
	AC-21A	AC-21B	Switching resistive loads including low overloads
	AC-22A	AC-22B	Switching mixed resistive and inductive loads, including low overloads
	AC-23A	AC-23B	Switching motors and other highly inductive loads
DC	DC-20A	DC-20B	Making and breaking without load
	DC-21A	DC-21B	Switching resistive loads including low overloads
	DC-22A	DC-22B	Switching mixed resistive and inductive loads, including low overloads (e. g. shunt motors)
	DC-23A	DC-23B	Switching highly inductive loads (e. g. series motors)

* The application of these utilization categories isn't permitted in the USA.

Category AC-23 includes occasional switching of individual motors. The utilization categories in the above table do not apply to an equipment normally used to start, accelerate and/or stop individual motors. The utilization categories for such an equipment are dealt with the following table:

Type of Current	Utilization Category	Typical applications
AC	AC-2	Slip-ring motors: starting, plugging ¹⁾ , switching off
	AC-3	Squirrel-cage motors: starting, switching off running motors
	AC-4	Squirrel-cage motors: starting, plugging ¹⁾ , inching ²⁾
DC	DC-3	Shunt motors: starting, plugging ¹⁾ , inching ²⁾ , dynamic breaking of d.c. motors
	DC-4	Series motors: starting, plugging ¹⁾ , inching ²⁾ , dynamic breaking of d.c. motors

¹⁾ Plugging is understood to mean stopping or reversing the motor rapidly by reversing motor primary connections while the motor is running.

²⁾ Inching (jogging) is understood to mean energizing a motor once or repeatedly for short periods to obtain small movements of the driven mechanism.

Note: The switching of rotor circuits, capacitors or tungsten filament lamps shall be subject to special agreements between manufacturer and user.

Rated currents of three-phase motors (approximate figures for squirrel-cage motors)

Motor rating			Motor full-load current			Fuse starting			Motor full-load current			Fuse starting		
kW	cos φ	Percent efficiency η %	A	D.O.L. A	Y/Δ A	A	D.O.L. A	Y/Δ A	A	D.O.L. A	Y/Δ A	A	D.O.L. A	Y/Δ A
			230 V						400 V					
0.06	0.7	58	0.37	2	—	0.21	2	—						
0.09	0.7	60	0.54	2	—	0.31	2	—						
0.12	0.7	60	0.72	4	2	0.41	2	—						
0.18	0.7	62	1.04	4	2	0.6	2	—						
0.25	0.7	62	1.4	4	2	0.8	4	2						
0.37	0.72	66	2	6	4	1.1	4	2						
0.55	0.75	69	2.7	10	4	1.5	4	2						
0.75	0.79	74	3.2	10	4	1.9	6	4						
1.1	0.81	74	4.6	10	6	2.6	6	4						
1.5	0.81	74	6.3	16	10	3.6	6	4						
2.2	0.81	78	8.7	20	10	5	10	6						
3	0.82	80	11.5	25	16	6.6	16	10						
4	0.82	83	14.8	32	16	8.5	20	10						
5.5	0.82	86	19.6	32	25	11.3	25	16						
7.5	0.82	87	26.4	50	32	15.2	32	16						
11	0.84	87	38	80	40	21.7	40	25						
15	0.84	88	51	100	63	29.3	63	32						
18.5	0.84	88	63	125	80	36	63	40						
22	0.84	92	71	125	80	41	80	50						
30	0.85	92	96	200	100	55	100	63						
37	0.86	92	117	200	125	68	125	80						
45	0.86	93	141	250	160	81	160	100						
55	0.86	93	173	250	200	99	200	125						
75	0.86	94	233	315	250	134	200	160						
90	0.86	94	279	400	315	161	250	200						
110	0.86	94	342	500	400	196	315	200						
132	0.87	95	401	630	500	231	400	250						
160	0.87	95	486	630	630	279	400	315						
200	0.87	95	607	800	630	349	500	400						
250	0.87	95	—	—	—	437	630	500						
315	0.87	96	—	—	—	544	800	630						
400	0.88	96	—	—	—	683	1000	800						
			500 V						690 V					
0.06	0.7	58	0.17	2	—	0.12	2	—						
0.09	0.7	60	0.25	2	—	0.18	2	—						
0.12	0.7	60	0.33	2	—	0.24	2	—						
0.18	0.7	62	0.48	2	—	0.35	2	—						
0.25	0.7	62	0.7	2	—	0.5	2	—						
0.37	0.72	66	0.9	2	2	0.7	2	—						
0.55	0.75	69	1.2	4	2	0.9	4	2						
0.75	0.79	74	1.5	4	2	1.1	4	2						
1.1	0.81	74	2.1	6	4	1.5	4	2						
1.5	0.81	74	2.9	6	4	2.1	6	4						
2.2	0.81	78	4	10	4	2.9	10	4						
3	0.82	80	5.3	16	6	3.8	10	4						
4	0.82	83	6.8	16	10	4.9	16	6						
5.5	0.82	86	9	20	16	6.5	16	10						
7.5	0.82	87	12.1	25	16	8.8	25	10						
11	0.84	87	17.4	32	20	12.6	25	16						
15	0.84	88	23.4	50	25	17	32	20						
18.5	0.84	88	28.9	50	32	20.9	32	25						
22	0.84	92	33	63	32	23.8	50	25						
30	0.85	92	44	80	50	32	63	32						
37	0.86	92	54	100	63	39	80	50						
45	0.86	93	65	125	80	47	80	63						
55	0.86	93	79	160	80	58	100	63						
75	0.86	94	107	200	125	78	160	100						
90	0.86	94	129	200	160	93	160	100						
110	0.86	94	157	250	160	114	200	125						
132	0.87	95	184	250	200	134	250	160						
160	0.87	95	224	315	250	162	250	200						
200	0.87	95	279	400	315	202	315	250						
250	0.87	95	349	500	400	253	400	315						
315	0.87	96	436	630	500	316	500	400						
400	0.88	96	547	800	630	396	630	400						



The rated motor currents are for standard 1500 r.p.m. motors with normal inner and outer surface cooling
 Fuse: This table applies to "slow" or "gL"
 D.O.L. starting: Maximum starting current: 6 × rated current. Maximum starting time: 5 sec.
 Y/Δ starting: Maximum starting current: 2 × rated current. Maximum starting time: 15 sec.

Degree of Protection / IP Codes

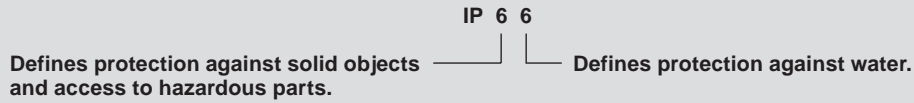
A coding system is defined by IEC 529 / EN60529 for the classification of degrees of protection provided by enclosures of electrical equipment against solid objects and water. This coding comprises the letters 'IP' followed by a two digit code as follows:

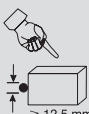
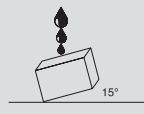
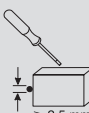
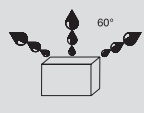
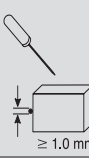
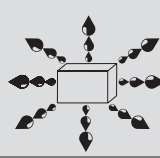
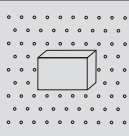
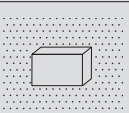
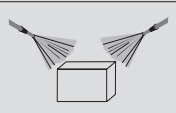
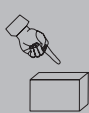
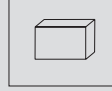
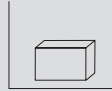

Degrees of protection indicated by a number up to and including "6" implies compliance with the requirements for all lower numbers. For a code with a second digit of 7 or 8, a second code must be stated to specify protection against water jets or spray, e. g. IP66/ IP67/ IP68.

1 st digit	Protection against solid objects and access to hazardous parts	2 nd digit	Protection against water
0	No protection.	0	No protection.
1	 No ingress by solid objects ≥ 50 mm dia nor access to hazardous parts with the back of the hand.	1	 Vertically falling drops of water shall have no harmful effect.
2	 No ingress by solid objects ≥ 12.5 mm dia nor access to hazardous parts with a finger.	2	 Vertically falling drops of water shall have no harmful effect when the enclosure is tilted at any angle up to 15° from vertical.
3	 No ingress by solid objects ≥ 2.5 mm dia nor access to hazardous parts with a tool.	3	 Water sprayed at up to 60° from the vertical shall have no harmful effect.
4	 No ingress by solid objects ≥ 1.0 mm dia nor access to hazardous parts with a wire.	4	 Water splashed from any direction shall have no harmful effect.
5	 Dust protected. Ingress of dust is not completely prevented, but there should be no harmful deposits. No access to hazardous parts with a wire.	5	 Jets of water projected from any direction shall have no harmful effect.
6	 Dust tight. No ingress of dust. No access to hazardous parts with a wire.	6	 Strong jets of water projected from any direction shall have no harmful effect.
1B	 Test finger penetration to a maximum of 80 mm must not contact hazardous parts.	7	 Temporary immersion in water shall not result in ingress of harmful quantities of water.
		8	 Continuous immersion in water shall not result in ingress of harmful quantities of water.

 **GERMANY**

Sälzer Electric GmbH

Matthiasstraße 16
57482 Wenden
T +49 (0) 27 62 - 6 14-110
F +49 (0) 27 62 - 6 14-100
info@salzer.de
www.saelzer.com

 **GREAT BRITAIN**

Salzer UK Ltd.

44 Edison Road
Aylesbury Bucks.
HP19 8TE
T +44 (0) 12 96 - 39 99 92
F +44 (0) 12 96 - 39 22 29
info@salzeruk.co.uk
www.saelzer.com

 **U.S.A./CANADA/MEXICO**

Salzer USA Corporation

3802 N. 54th Street
Mesa, AZ 85215
T +1 480-325-2690
F +1 480-985-9663
info@salzerusa.com
www.saelzer.com

 **AUSTRIA**

Schmachtl GmbH
Pummererstrasse 36
4020 Linz
T +43 (0) 7 32 - 76 46-0
F +43 (0) 7 32 - 78 50 36
office.linz@schmachtl.at
www.schmachtl.at

 **BELGIUM
LUXEMBURG**

Bintz technics N. V.
Brixtonlaan 25
Business Park
1930 Zaventem
T +32 (0) 2 - 720 49 16
F +32 (0) 2 - 720 37 50
info@bintz.be
www.bintz.be

 **CZECHIA
SLOVAKIA**

WAPRO spol. s r.o.
Rumunská 27
796 01 Prostějov
T +420 582 334 676
F +420 582 334 677
info@wapro.cz
www.wapro.cz

 **DENMARK**

Gycom Danmark A/S
Vallørækket 26
Valløby
4600 Køge
T +45 - 56 26 66 35
F +45 - 56 26 77 78
gycomdk@gycom.com
www.gycom.dk

 **FINLAND
ESTONIA
LATVIA**

UTU POWEL OY
Box 33
04251 Kerava
T +358 - 9 - 2746 411
F +358 - 9 - 2746 4141
komponentit@utu.eu
www.urhotuominen.fi

 **IRELAND**

MCC Controls Ltd.
Robinhood Business Park
Robinhood Rd.
22 Dublin
T +353 (0) 1 - 4 50 64 50
F +353 (0) 1 - 4 50 61 04
sales@mcc-controls.com
www.mcc-controls.com

 **ITALY**

Telestar S. r. l.
Via C. Colombo, 13
22069 Rovellasca (CO)
T +39 (0) 02 96 74 02 68
F +39 (0) 02 96 74 02 73
telestar@telestar-automation.it
www.telestar-automation.it

 **KUWAIT**

The United Towers
Trading & Contracting Est.
Old Khaitan,
Block 45+46, Building 12
KWT 13157 Office No.1,
Mezzanine
T +965 - 24745960
F +965 - 24727452
theunitedtowers@yahoo.com

 **NETHERLANDS**

Solar Nederland B.V.
Effect 5
6921 RG Duiven
T +31 (0) 26 - 3 65 22 29
F +31 (0) 26 - 3 65 22 20
industrie@solarnederland.nl
www.solarnederland.nl

 **NORWAY**

EFA ELEKTRO A. S.
Postboks 593
1411 Kolbotn
T +47 - 6681 2400
F +47 - 6680 0478
post@efa.no
www.efa.no

 **SINGAPORE**

Electrimec Asia Pacific Pte Ltd
No.9 Toh Guan Road East
ALLIANCE Building # 03-01
Singapore 608604
T +65 - 6896 2979
F +65 - 6896 2925
elecmecc@singnet.com.sg

 **SOUTH AFRICA**

Waco Industries
11, Cleveland Road
Cleveland – Johannesburg
T +27 (0) 11 - 677 2500
F +27 (0) 11 - 677 2608
wacobuy@voltex.co.za
www.wacoelec.co.za

 **SPAIN**

Euromatel S. L.
Avenida Real de Pinto, 87
Nave II-A
28021 Madrid
T +34 - 91 - 3 58 92 70
F +34 - 91 - 3 58 92 95
info@euromatel.es
www.euromatel.es

 **SWEDEN**

Gycom Svenska AB
Box 1203
183 12 Täby
T +46 - 8 - 562 011 00
F +46 - 8 - 792 06 54
info@gycom.se
www.gycom.se

 **SWITZERLAND**

EHS Elektrotechnik AG
Industriestrasse 26
8604 Volketswil
T +41 (0) 44 - 908 40 50
F +41 (0) 44 - 908 40 55
info@ehs.ch
www.ehs.ch

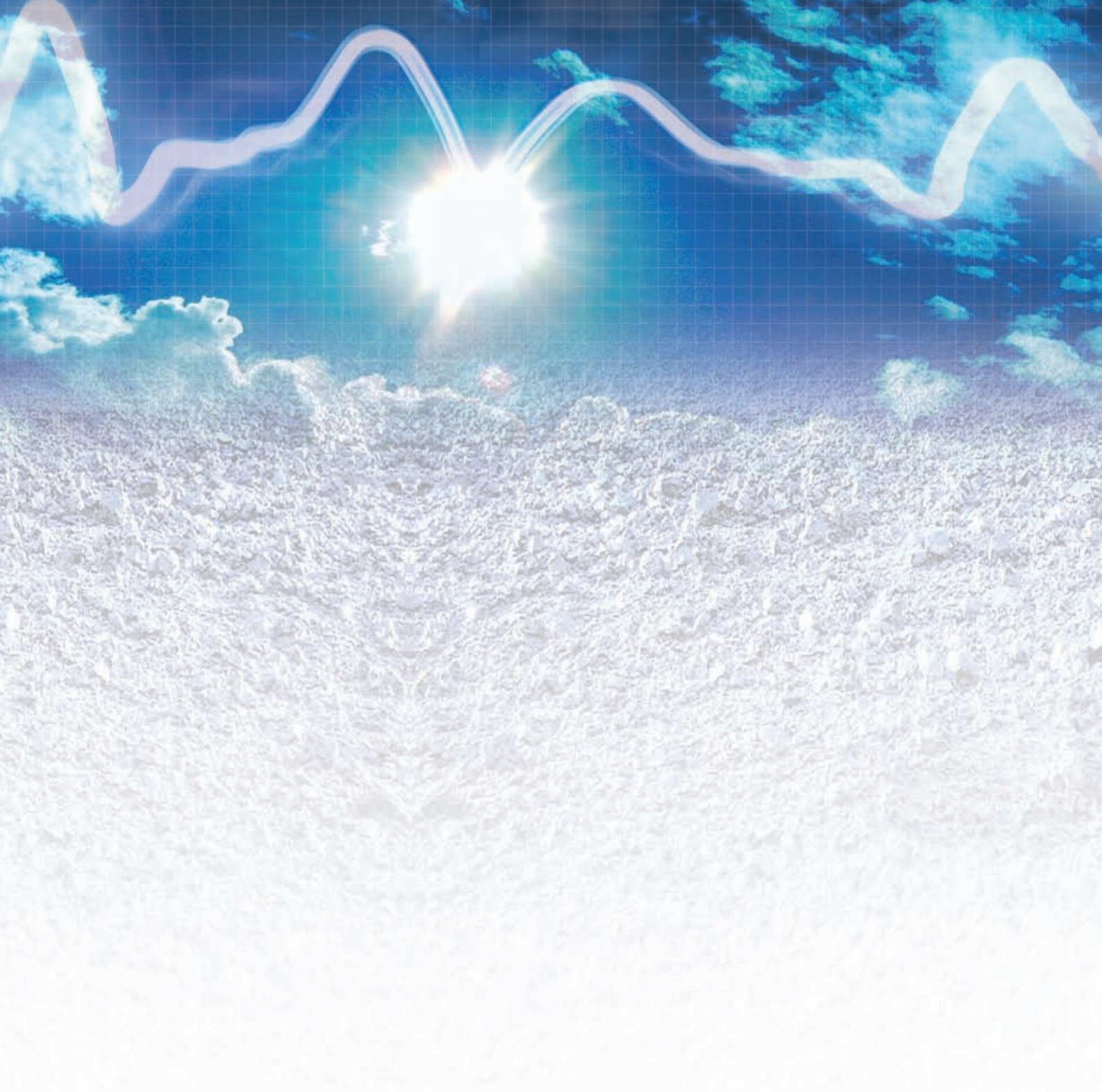

sälzer

Sälzer Electric GmbH
Matthiasstraße 16
57482 Wenden
www.saelzer.com

Headquarters:
Tel. +49 (0) 27 62/ 614-110
Fax +49 (0) 27 62/ 614-100
sales@salzer.de

Technical Support:
Tel. +49 (0) 37 37/ 87-0
Fax +49 (0) 37 37/ 87-226
support@salzer.de