

TZN/TZ Series

Dual PID Control Temperature Controller

■ Features

- Dual PID auto tuning function:
High-speed response of PID control to reach to the desired value fast, low-speed of response of PID control to minimize the overshoot even though response is a little bit slow.
- High display accuracy: $\pm 0.3\%$ (by F.S. value of each input)
- 2-step auto tuning control function
- Multi-input function
(13 kinds of multi-input selection function):
Temperature sensor, voltage and current selection function.
- Various sub output function:
Includes in LBA, SBA, 7 kinds of alarm output and 4 kinds of alarm option function, PV transmission output (DC4-20mA), RS485 communication output
- Display the decimal point for analog input



⚠ Please read "Safety Considerations" in the instruction manual before using.



■ Comprehensive Device Management Program (DAQMaster)

- DAQMaster is comprehensive device management program for convenient management of parameters and multiple device data monitoring.
 - Visit our website (www.autonics.com) to download user manual and comprehensive device management program.
- < Computer specification for using software >

Item	Minimum requirements
System	IBM PC compatible computer with Intel Pentium III or above
Operating system	Microsoft Windows 98/NT/XP/Vista/7/8/10
Memory	256MB or more
Hard disk	More than 1GB of free hard disk space
VGA	1024×768 or higher resolution display
Others	RS-232 serial port (9-pin), USB port

< DAQMaster screen >

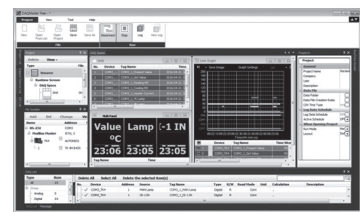

■ Ordering Information

TZ 4 M - 1 4 R



Item	Minimum requirements
System	IBM PC compatible computer with Intel Pentium III or above
Operating system	Microsoft Windows 98/NT/XP/Vista/7/8/10
Memory	256MB or more
Hard disk	More than 1GB of free hard disk space
VGA	1024×768 or higher resolution display
Others	RS-232 serial port (9-pin), USB port
Control output	R Relay output
	S SSR drive output
	C Current output(DC4-20mA)
Power supply	4 100-240VAC 50/60Hz
Option output	TZ4SP/TZN4S 1 Event 1 output
	TZ4ST 1 Event 1 output
	2 Event 1 + Event 2 output
	R Event 1 + PV transmission output(DC4-20mA)
	Others 1 Event 1 output
	2 Event 1 + Event 2 output
	R Event 1 + PV transmission output(DC4-20mA)
	A Event 1 + Event 2 + PV transmission output(DC4-20mA)
	T Event 1 + RS485 communication output
	B Event 1 + Event 2 + RS485 communication output
Size	TZN4 S DIN W48×H48mm (terminal block type)
	TZ4 SP DIN W48×H48mm (plug type) ^{※1}
	ST DIN W48×H48mm (terminal block type)
	M DIN W72×H72mm
	W DIN W96×H48mm
	H DIN W48×H96mm
	L DIN W96×H96mm
Digit	4 9999 (4-digit)
	TZ Temperature Controller
	TZN Temperature Controller

※The unit cannot be configured with any random combination from the above ordering information.

Please refer to '■ Specifications' for possible configurations.

※1: 11-pin sockets (PG-11, PS-11(N)) are sold separately.

■ Specifications

Series		TZ4SP TZN4S	TZ4ST	TZ4M TZN4M	TZ4W TZN4W	TZ4H TZN4H	TZ4L TZN4L
Power supply		100-240VAC~ 50/60Hz					
Allowable voltage range		90 to 110% of rated power voltage					
Power consumption		Max. 5VA (100-240VAC~ 50/60Hz)			Max. 6VA (100-240VAC~ 50/60Hz)		
Display method		7-segment LED (PV: red, SV: green)					
Character size (W×H)	PV	TZ4SP: 4.8×7.8mm TZN4S: 7.8×11.0mm	4.8×7.8mm	TZ4M: 9.8×14.2mm TZN4M: 8.0×13.0mm	8.0×10.0mm	TZ4H: 3.8×7.6mm TZN4H: 7.8×11.0mm	9.8×14.2mm
	SV	TZ4SP: 4.8×7.8mm TZN4S: 5.8×8.0mm		TZ4M: 8.0×10.0mm TZN4M: 5.0×9.0mm		TZ4H: 3.8×7.6mm TZN4H: 5.8×8.0mm	
Input type	RTD	DPT100Ω, JPT100Ω, 3-wire (allowed resistance: max. 5Ω per line)					
	TC	K(CA), J(IC), R(PR), E(CR), T(CC), S(PR), N(NN), W(TT) (allowed resistance: max. 100Ω per line)					
	Analog	1-5VDC≒, 0-10VDC≒, DC4-20mA					
Display accuracy		F.S. ±0.3% or 3°C, greater value					
Control output	Relay	250VAC~ 3A, 30VDC≒ 3A, 1c					
	SSR	Max. 12VDC≒ ±3V 30mA					
	Current	DC4-20mA (load resistance max. 600Ω)					
Option output	EVENT1	250VAC~ 1A 1a					
	EVENT2	—	250VAC~ 1A 1a				
	PV transmission	—	DC4-20mA (load resistance max. 600Ω)				
	Communication	—	RS485 communication				
Control method		ON/OFF, P, PI, PD, PIDF, PIDS control					
Alarm output hysteresis		1 to 100°C (0.1 to 100.0°C) variable					
Proportional band (P)		0.0 to 100.0%					
Integral time (I)		0 to 3,600 sec					
Derivative time (D)		0 to 3,600 sec					
Control period (T)		1 to 120 sec					
Sampling period		0.5 sec					
LBA setting		1 to 999 sec					
Ramp setting		Ramp Up, Ramp Down: 1 to 99 min each					
Dielectric strength		2,000VAC 50/60Hz for 1 min (between input and power terminals)					
Vibration	Mechanical	0.75mm amplitude at frequency 10 to 55Hz (for 1 min) in each X, Y, Z direction for 2 hours					
	Electrical	0.5mm amplitude at frequency 10 to 55Hz (for 1 min) in each X, Y, Z direction for 10 min					
Relay life cycle	Control output	Mechanical: min. 10,000,000 operations, Electrical: min. 100,000 operations (250VAC 3A resistance load)					
	Option output	Mechanical: min. 20,000,000 operations, Electrical: min. 500,000 operations (250VAC 1A resistance load)					
Insulation resistance		Over 100MΩ (at 500VDC megger)					
Noise immunity		Square shaped noise by noise simulator (pulse width 1μs) ±2kV R-phase, S-phase					
Memory retention		Approx. 10 years (non-volatile semiconductor memory type)					
Environment	Ambient temp.	-10 to 50°C, storage: -20 to 60°C					
	Ambient humi.	35 to 85%RH, storage: 35 to 85%RH					
Approval		  					
Weight ^{*1}		TZ4SP: approx. 205g (approx. 144g) TZN4S: approx. 226g (approx. 164g)	Approx. 218g (approx. 162g)	TZ4M: approx. 360g (approx. 228g) TZN4M: approx. 355g (approx. 246g)	TZ4W: approx. 365g (approx. 246g) TZN4W: approx. 351g (approx. 232g)	TZ4H: approx. 365g (approx. 246g) TZN4H: approx. 351g (approx. 232g)	TZ4L: approx. 474g (approx. 304g) TZN4L: approx. 474g (approx. 303g)

*1: The weight includes packaging. The weight in parenthesis is for unit only.

※Environment resistance is rated at no freezing or condensation.

SENSORS

CONTROLLERS

MOTION DEVICES

SOFTWARE

(J) Temperature Controllers

(K) SSRs

(L) Power Controllers

(M) Counters

(N) Timers

(O) Digital Panel Meters

(P) Indicators

(Q) Converters

(R) Digital Display Units

(S) Sensor Controllers

(T) Switching Mode Power Supplies

(U) Recorders

(V) HMIs

(W) Panel PC

(X) Field Network Devices

TZN/TZ Series



Connections

※RTD: DPT100Ω (3-wire type), JPt100Ω (3-wire type)

※TC (Thermocouple): K(CA), J(IC), R(PR), E(CR), T(CC), S(PR), N(NN), W(TT)

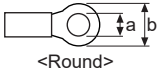

※In case of analog input, please use TC (Thermocouple) terminal and be careful about polarity.

※Use terminals of size specified below.

		
a	Min. 3.5mm	Min. 3.5mm
b	Max. 7.2mm	Max. 7.2mm

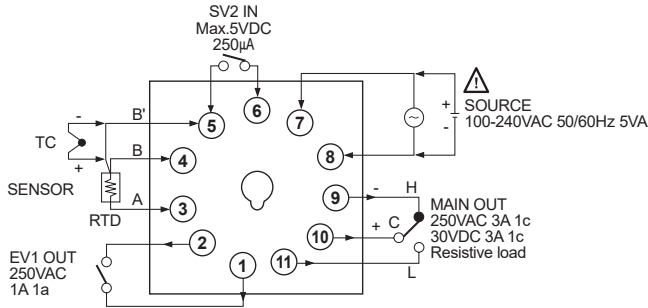

● TZ4SP



MAIN OUT	
SSR	Current
	
12VDC ±3V 30mA Max.	DC4-20mA Load 600Ω Max.

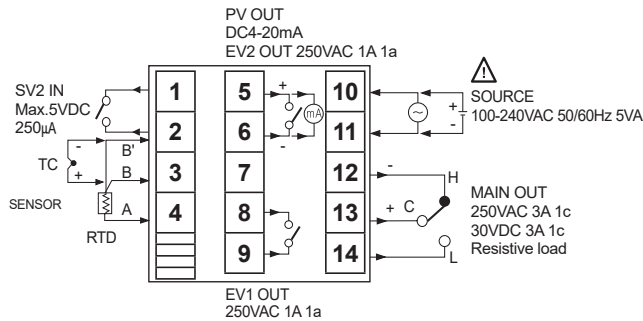

● TZ4ST



MAIN OUT	
SSR	Current
	
12VDC ±3V 30mA Max.	DC4-20mA Load 600Ω Max.

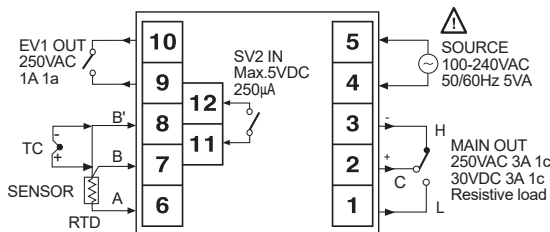

● TZN4S

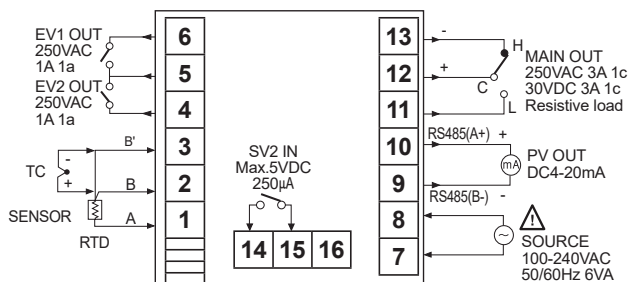

MAIN OUT	
SSR	Current
	
12VDC ±3V 30mA Max.	DC4-20mA Load 600Ω Max.

● TZ4M



MAIN OUT	
SSR	Current
	
12VDC ±3V 30mA Max.	DC4-20mA Load 600Ω Max.

Dual PID Control

● TZ4M

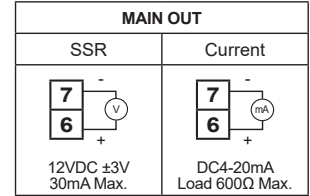
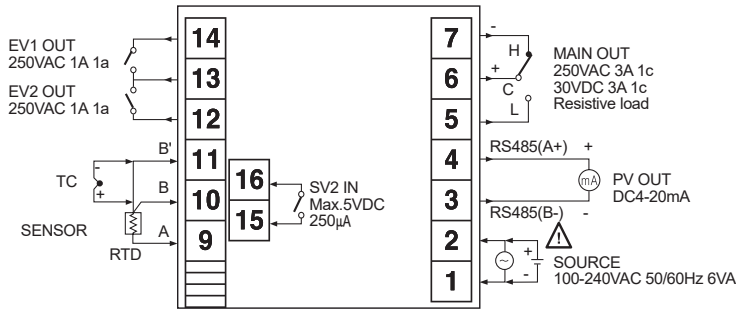

● TZ4W/TZ4W

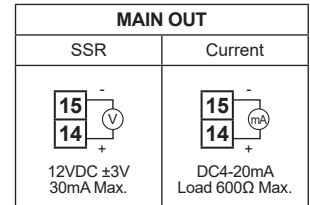
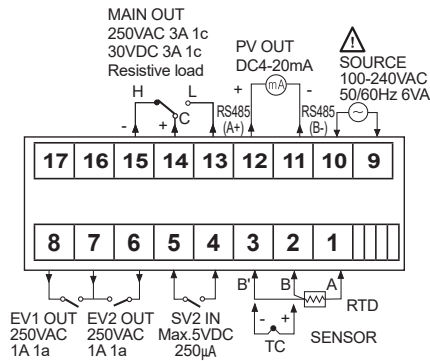

● TZ4H/TZ4H

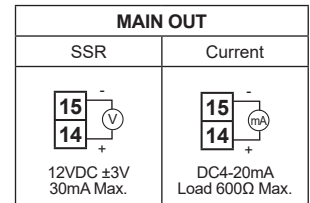
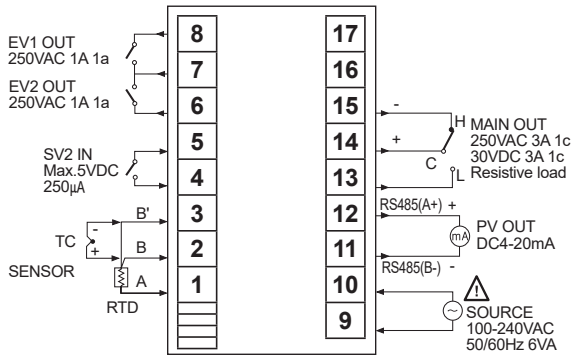

● TZ4L/TZ4L

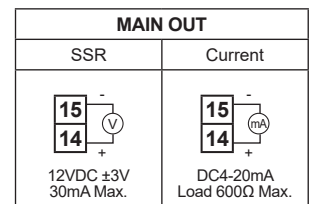
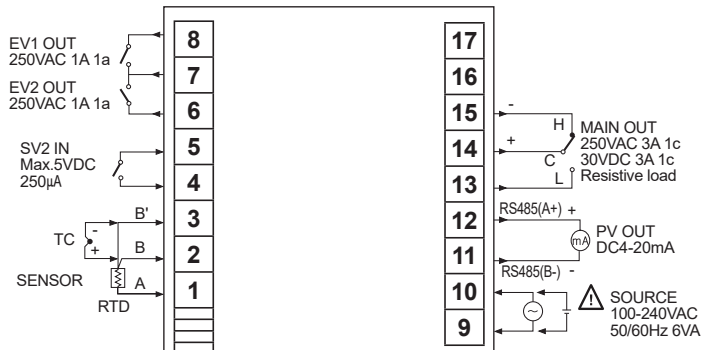

SENSORS

CONTROLLERS

MOTION DEVICES

SOFTWARE

(J) Temperature Controllers

(K) SSRs

(L) Power Controllers

(M) Counters

(N) Timers

(O) Digital Panel Meters

(P) Indicators

(Q) Converters

(R) Digital Display Units

(S) Sensor Controllers

(T) Switching Mode Power Supplies

(U) Recorders

(V) HMIs

(W) Panel PC

(X) Field Network Devices

TZN/TZ Series

■ Dimensions

(unit: mm)

● TZ4SP

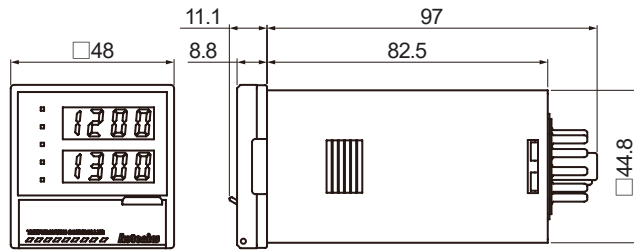

● TZ4ST

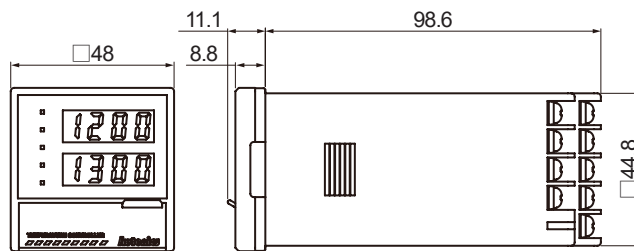

● TZN4S

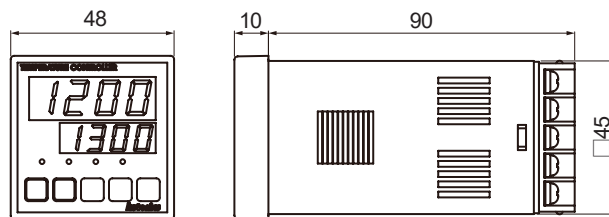

● TZ4M

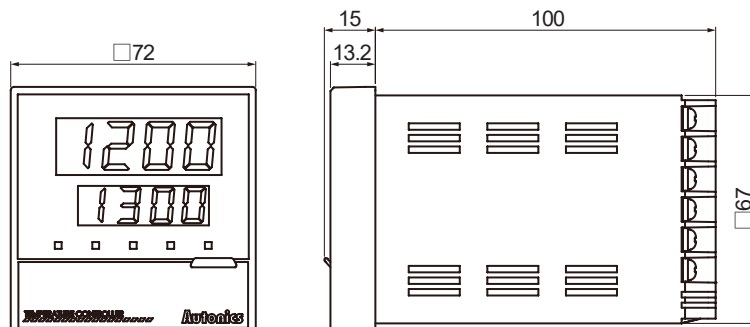

Dual PID Control

● TZN4M

(unit: mm)

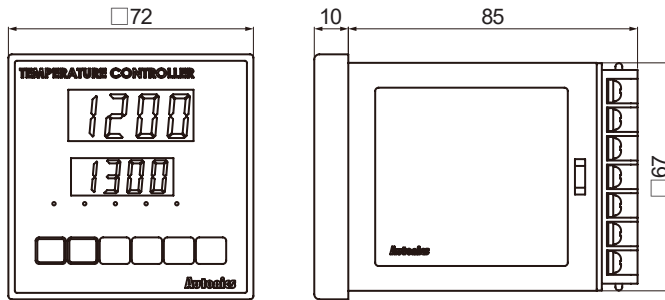

SENSORS
CONTROLLERS
MOTION DEVICES
SOFTWARE

● TZ4W

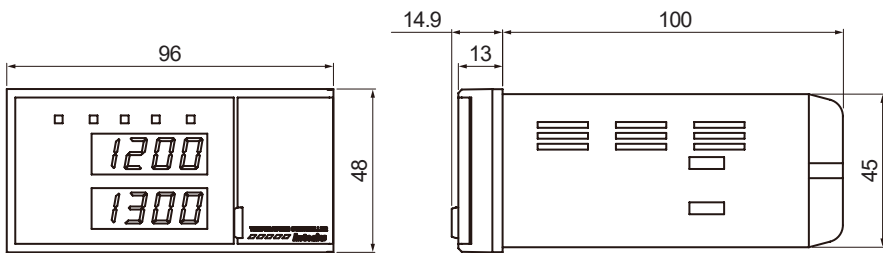

(J) Temperature Controllers
(K) SSRs
(L) Power Controllers
(M) Counters

● TZN4W

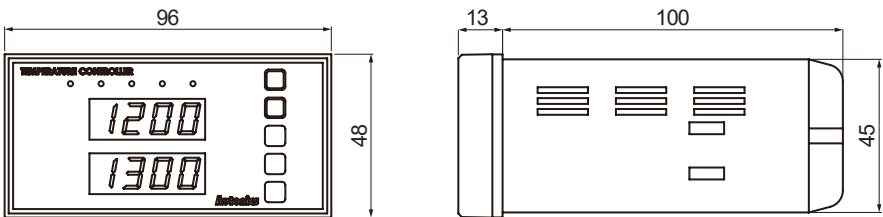

(N) Timers
(O) Digital Panel Meters
(P) Indicators
(Q) Converters

● TZ4H

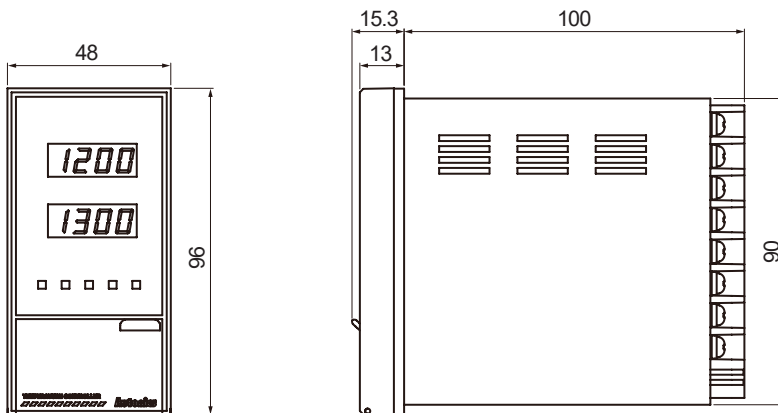

(R) Digital Display Units
(S) Sensor Controllers
(T) Switching Mode Power Supplies
(U) Recorders
(V) HMIs
(W) Panel PC
(X) Field Network Devices

TZN/TZ Series

● TZN4H

(unit: mm)

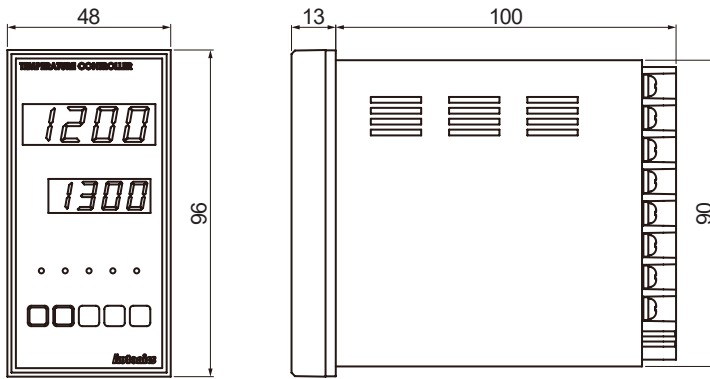

● TZ4L

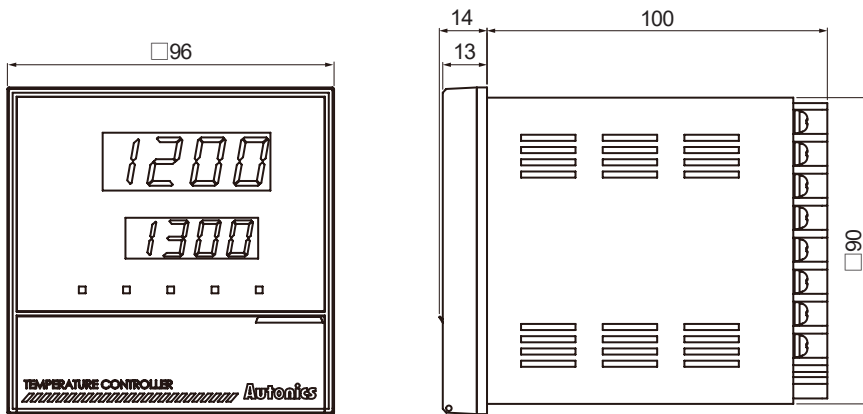

● TZN4L

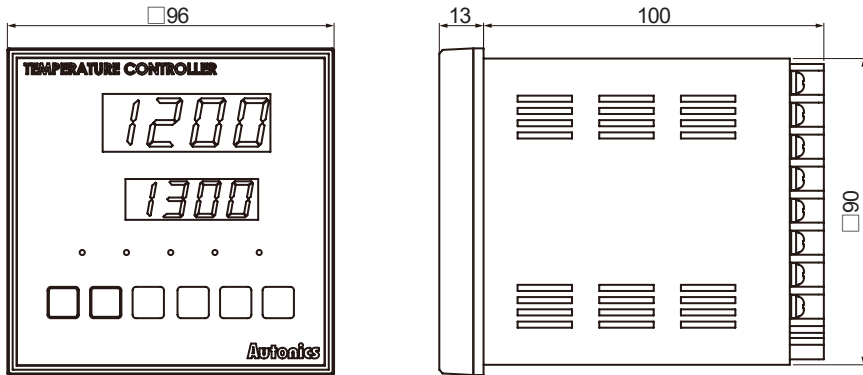

● Panel cut-out dimensions

(unit: mm)

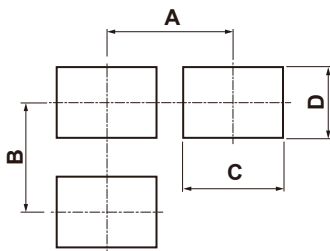

Series	Size			
	A	B	C	D
TZ4SP, TZ4ST, TZN4S	Min. 55	Min. 62	45 ^{+0.6} ₀	45 ^{+0.6} ₀
TZ4M	Min. 74	Min. 91	68 ^{+0.7} ₀	68 ^{+0.7} ₀
TZN4M	Min. 91	Min. 91	68 ^{+0.7} ₀	68 ^{+0.7} ₀
TZ4W, TZN4W	Min. 112	Min. 50	92 ^{+0.8} ₀	45 ^{+0.6} ₀
TZ4H, TZN4H	Min. 50	Min. 102	45 ^{+0.6} ₀	92 ^{+0.8} ₀
TZ4L, TZN4L	Min. 98	Min. 106	92 ^{+0.8} ₀	92 ^{+0.8} ₀

Dual PID Control

- Bracket
- TZ4ST, TZ4SP, TZN4S Series

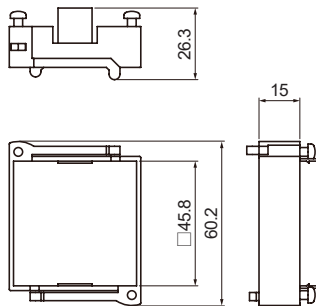

- TZ4L, TZN4L, TZ4M, TZ4H, TZN4H, TZ4W, TZN4W Series

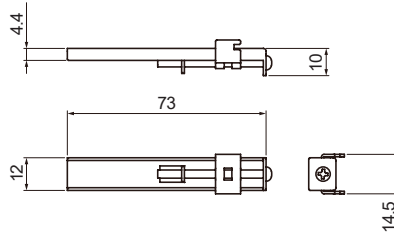

- TZN4M Series

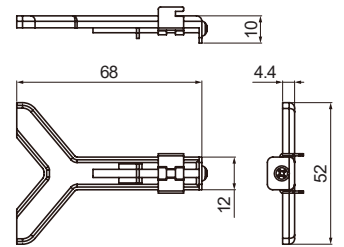

(unit: mm)

■ Sold Separately

◎ Communication converter

- SCM-WF48 (Wi-Fi to RS485·USB wireless communication converter)



- SCM-US481 (USB to RS485 converter)



- SCM-381 (RS232C to RS485 converter)



■ Input Type and Range

Input type		Decimal point	Display	Temperature range (°C)	Temperature range (°F)
Thermocouple	K(CA)	1	℄CRH	-100 to 1300	-148 to 2372
	K(CA)	0.1	℄CRL	-100.0 to 999.9	Not supported
	J(IC)	1	℄ICH	0 to 800	32 to 1472
	J(IC)	0.1	℄ICL	0.0 to 800.0	Not supported
	R(PR)	1	r Pr	0 to 1700	32 to 3092
	E(CR)	1	℄CrH	0 to 800	32 to 1472
	E(CR)	0.1	℄CrL	0.0 to 800.0	Not supported
	T(CC)	1	℄CCH	-200 to 400	-328 to 752
	T(CC)	0.1	℄CCL	-199.9 to 400.0	Not supported
	S(PR)	1	s Pr	0 to 1700	32 to 3092
	N(NN)	1	n nn	0 to 1300	32 to 2372
RTD	W(TT)	1	℄Tt	0 to 2300	32 to 4172
	JPt100Ω	1	℄PtH	0 to 500	32 to 932
	JPt100Ω	0.1	℄PtL	-199.9 to 199.9	-199.9 to 391.8
	DPt100Ω	1	dPtH	0 to 500	32 to 932
Analog	Voltage	0 - 10VDC	R - 1	-1999 to 9999 (display range will vary depending on the decimal point.)	
		1 - 5VDC	R - 2		
	Current	DC4 - 20mA	R - 3		

SENSORS

CONTROLLERS

MOTION DEVICES

SOFTWARE

(J) Temperature Controllers

(K) SSRs

(L) Power Controllers

(M) Counters

(N) Timers

(O) Digital Panel Meters

(P) Indicators

(Q) Converters

(R) Digital Display Units

(S) Sensor Controllers

(T) Switching Mode Power Supplies

(U) Recorders

(V) HMIs

(W) Panel PC

(X) Field Network Devices

TZN/TZ Series

■ Configuring Input Type

Please configure the internal switches before supplying power. After supplying power, configure the input type [1-1-1] in parameter group 2 according to the input type.

Input type	S/W 1	S/W 2
Thermocouple		
RTD	1 1	mA V
Analog		
	Voltage (0-10VDC, 1-5VDC)	mA V
Current (DC4-20mA)	2 2	mA V

● Detaching the case

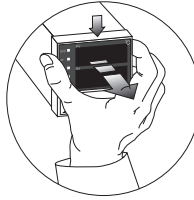

Press the front case then pull the case to detach the case from the body.
Configure the internal switches as input type.

■ Unit Description

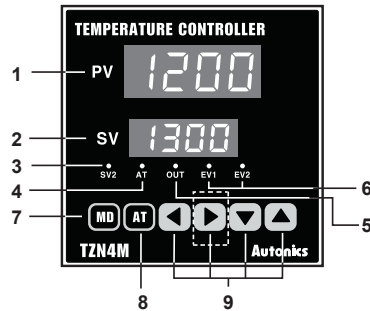
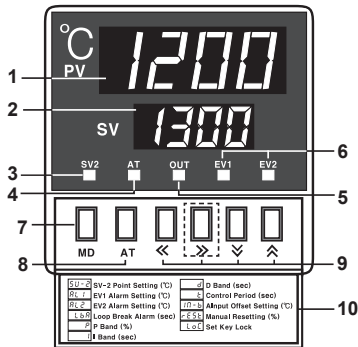

- 1. Present value (PV) display (red):**
RUN mode: displays the current value (PV)
Setting mode: displays parameters
- 2. Set value (SV) display (green):**
RUN mode: displays the set value (SV)
Setting mode: displays parameter setting values
- 3. SV2 operation indicator:** turns ON when SV2 is operating
- 4. Auto-tuning indicator:** turns ON when auto-tuning
- 5. Control output operation indicator:** turns ON when control output is ON. Does not operate when the control output is current output.
- 6. Event output indicator:** turns ON when the according event output is ON.
※The Event 2 output indicator does not operate in TZ4SP.
- 7. Mode key:** enter parameter group, return to RUN mode, switch parameters, save setting values
- 8. Auto-tuning key:** hold the key for 3 sec to start auto-tuning. Hold the key for 5 sec while auto-tuning to stop auto-tuning.
- 9. Setting keys:** enter SV change mode, switch fields, change value
(key in the dotted line is only available in TZ4M and TZ4L models)
- 10. Key adjustment order chart**

■ SV Setting

※When changing the previous SV of 0°C to 170°C,

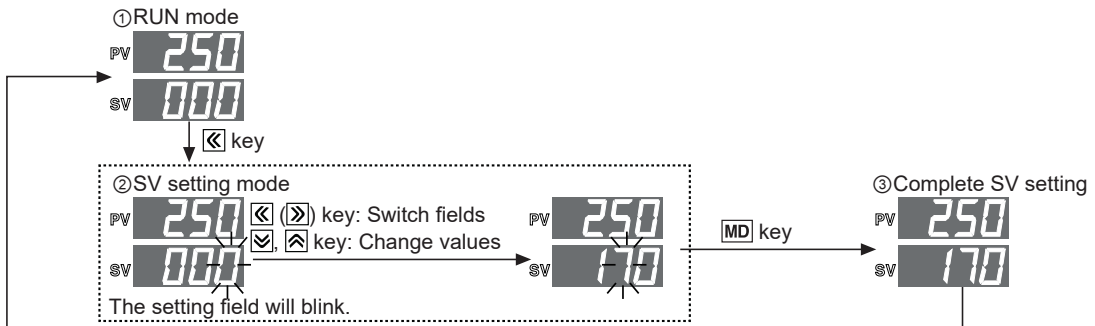

Dual PID Control

Parameter Group

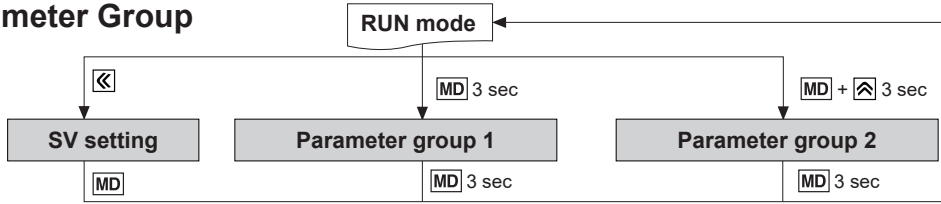

※Parameter setting order **Parameter group 2** → **Parameter group 1** → **SV setting**

The parameters are related to each other. Please set the parameters in the order above.

※When there is no key input for 60 sec while in SV setting mode or parameter groups, the unit will return to RUN mode automatically.

Parameter group 1

※1: **S**: **[]** key-Switch fields, **[]**, **[]** key-Change values

※2: Press the **[MD]** key after checking or changing the values in parameter settings to save the setting value and move to the next parameter.

※Hold the **[MD]** key for 3 sec anytime during parameter settings to save the setting value and return to RUN mode.

※The dotted line parameters [] may not appear depending on the model or other parameter settings.

Setting range: refer to **[]** Input Type and Range'.

Setting range: refer to **[]** Input Type and Range'.

※[AL 1, AL 2] parameters do not appear when Event 1/2 [EU - 1, EU - 2] of parameter group 2 is set to AL - 0, LbA, 5bA.

※[AL 2] parameter only appears in models that support Event 2 output.

Setting range: 0 to 999 sec

※Only appears when Event1/2 [EU - 1, EU - 2] of parameter group 2 is set to LbA.
 ※Does not appear in current output models.

Setting range: 1 to 100°C/°F (0.1 to 100.0°C/°F)

※Does not appear when Event 1/2 [EU - 1, EU - 2] of parameter group 2 is set to AL - 0, LbA, 5bA.

Setting range: 0.0 to 100.0%

※ON/OFF control: Set to 0.0, PID control: Set to over 0.0

Setting range: 0 to 3,600 sec

※Integral operation is turned OFF when set to 0.

Setting range: 0 to 3,600 sec

※Derivative operation is turned OFF when set to 0.

Setting range: 1 to 120 sec

※Set to a small value in SSR drive output models. (e.g. 2 sec)
 ※Does not appear in current output models.

Setting range: 1 to 100°C/°F (0.1 to 100.0°C/°F)

※Only appears during ON/OFF control (proportional band [P] set to 0.0).

Setting range: -49 to 50°C/°F (-50.0 to 50.0°C/°F)

Setting range: 0.0 to 100%

※Only appears when P control (proportional band [P] set to over 0.0, integral time [I], and derivative time [d] are set to 0)

Setting range: 1 to 99 min

※Only appears when ramp function [RAP] of parameter group 2 is set to on.

Setting range: 0FF Unlock

0n Lock parameter 1 (AT key available)

0n I Lock parameter 1 (AT key unavailable)

- SENSORS
- CONTROLLERS
- MOTION DEVICES
- SOFTWARE

- (J) Temperature Controllers
- (K) SSRs
- (L) Power Controllers
- (M) Counters
- (N) Timers
- (O) Digital Panel Meters
- (P) Indicators
- (Q) Converters
- (R) Digital Display Units
- (S) Sensor Controllers
- (T) Switching Mode Power Supplies
- (U) Recorders
- (V) HMIs
- (W) Panel PC
- (X) Field Network Devices

TZN/TZ Series

Parameter group 2

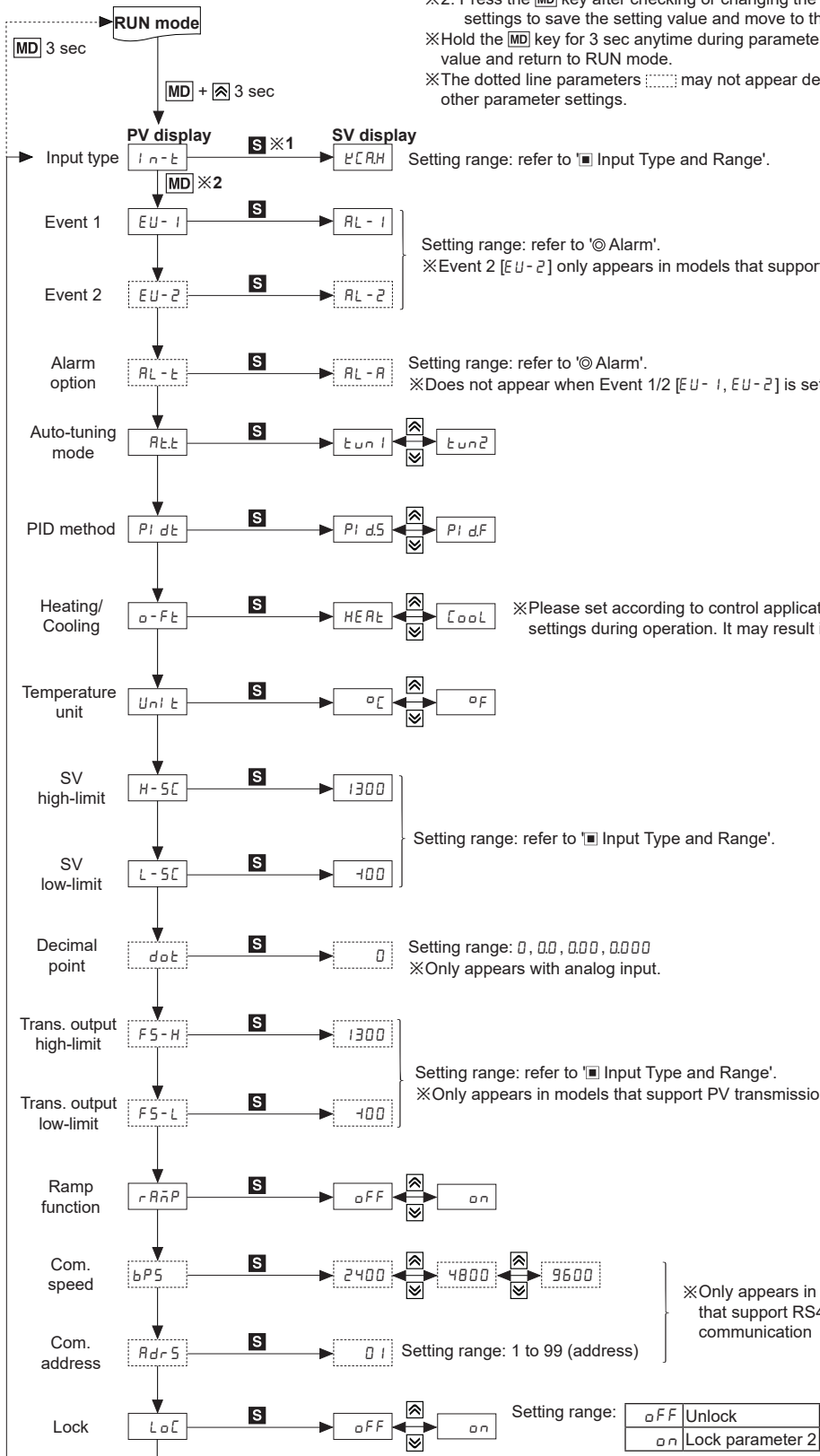

- ※1: **S** (key-Switch fields), **↔** (key-Change values)
- ※2: Press the **MD** key after checking or changing the values in parameter settings to save the setting value and move to the next parameter.
- ※Hold the **MD** key for 3 sec anytime during parameter settings to save the setting value and return to RUN mode.
- ※The dotted line parameters **⋯** may not appear depending on the model or other parameter settings.

Factory Defaults

Parameter group 1

Parameter	Default	Parameter	Default	Parameter	Default
SV-2	0	P	30	ln-b	0
AL1	10	i	0	rESL	0.0
AL2	10	d	0	rAPU	10
LbA	600	t	20	rAPd	10
RHYS	2	HYS	2	LcC	oFF

Parameter group 2

Parameter	Default	Parameter	Default	Parameter	Default
ln-t	oCRH	o-Ft	HErE	F5-L	100
EU-1	AL-1	Unlt	oC	rANP	oFF
EU-2	AL-2	H-5C	1300	bPS	2400
AL-t	AL-A	L-5C	100	Ad-S	01
At-t	tunl	dot	0	LcC	oFF
PI dt	PI dS	F5-H	1300		

Functions

SV 2 temperature

You can control an additional temperature value at a desired range by using SV2. Connect a contact signal (under 5VDC, 250μA) at the external terminal, to operate in the range where the signal turns ON. Set the SV2 temperature in SV2 temperature [SV-2] in parameter group 1.

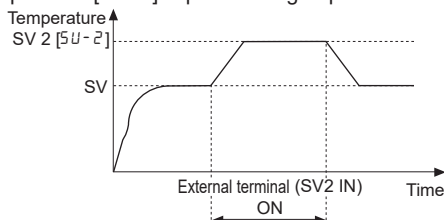

E.g.) The internal temperature of an electric oven may drop rapidly if the door is opened while the oven is maintaining a specific temperature. Set SV2 temperature [SV-2] to a higher value than SV, and input a signal to the external terminal (SV2 IN), to quickly raise the temperature.

Auto-tuning

Auto-tuning allows the temperature controller to detect the thermal characteristics and response rates of the control target. It then calculates the PID time constant and sets the value to allow fast response rates and high accuracy. Hold the [AT] key for 3 sec during RUN mode to start auto-tuning. The auto-tuning indicator will blink. When auto-tuning is completed, the auto-tuning indicator will turn off and the PID time constant will be saved to each parameter of parameter group 1. The saved parameters can be adjusted as desired.

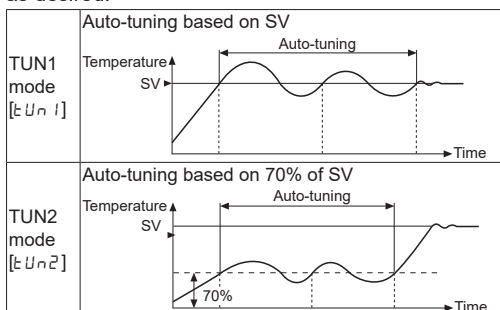

To manually stop auto-tuning, hold the [AT] key for 5 sec. When auto-tuning is stopped, the controller maintains the PID value before auto-tuning. TZ Series supports 2 auto-tuning modes.

Select TUN1 mode or TUN2 mode [tUn1, tUn2] from auto-tuning mode [At.t] of parameter group 2.

※Run auto-tuning during initial setup of the temperature controller.

※If the thermal characteristics of the control target device has changed after extended usage, re-run auto-tuning.

Ramp

The ramp function can delay the rate of temperature rise/fall. If the SV value is changed during stabilized control, the temperature of the controlled target will rise/fall during ramp up/down time [rAPU, rAPd] of parameter group 1. The ramp function activates when the power is reset or when the SV value is changed during stable control.

※The ramp up/down time [rAPU, rAPd] appear only when the ramp function [rANP] of parameter group 2 is set to on.

•RAMP up time[rAPU]

When delaying the rise of initial control temperature or changing the SV during stable control, you can delay temperature rise. Set the ramp up time [rAPU] longer than the temperature rise time (tu) when not using the ramp function.

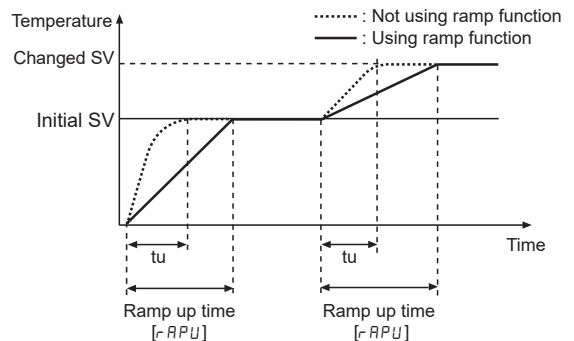

•Ramp down time [rAPd]

Delays declining temperature. Set the ramp down time [rAPd] longer than the temperature decline time (td) when not using the ramp function.

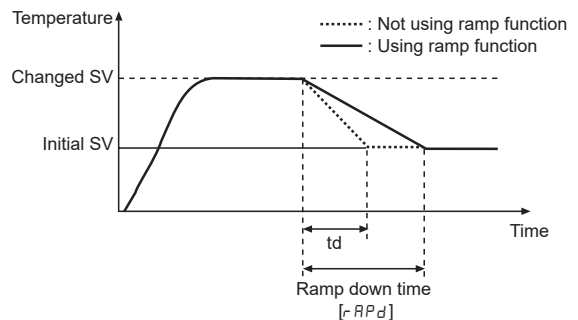

SENSORS
CONTROLLERS
MOTION DEVICES
SOFTWARE
(J) Temperature Controllers
(K) SSRs
(L) Power Controllers
(M) Counters
(N) Timers
(O) Digital Panel Meters
(P) Indicators
(Q) Converters
(R) Digital Display Units
(S) Sensor Controllers
(T) Switching Mode Power Supplies
(U) Recorders
(V) HMIs
(W) Panel PC
(X) Field Network Devices

TZN/TZ Series

⊙ Alarm (event)

Alarm output can be configured by combining alarm operation and alarm options. Set the alarm operation in event 1/2 [E U 1, E U 2] of parameter group 2, and set the alarm options in alarm option [RL - E].

1) Alarm operation

Mode	Name	Alarm operation	Description
RL - 0	—	—	Alarm output not used.
RL - 1	Deviation high-limit alarm		If the deviation of PV and SV are higher than the high-limit deviation, the alarm output turns ON.
RL - 2	Deviation low-limit alarm		If the deviation of PV and SV are higher than the low-limit deviation, the alarm output turns ON.
RL - 3	Deviation high-limit /low-limit alarm		If the deviation of PV and SV are higher than the high-limit deviation or low-limit deviation, the alarm output turns ON.
RL - 4	Deviation high-limit /low-limit reverse alarm		If the deviation of PV and SV are higher than the high-limit deviation or low-limit deviation, the alarm output turns OFF.
RL - 5	Absolute value high-limit alarm		Alarm output turns ON when PV is higher than the absolute value.
RL - 6	Absolute value low-limit alarm		Alarm output turns ON when PV is lower than the absolute value.
S b R	Sensor break	—	Alarm output turns ON when sensor disconnection is detected.
L b R	Loop break	—	Alarm output turns ON when loop break is detected.

※ H: Alarm output hysteresis[RH H 5]

2) Alarm options

Mode	Name	Description
RL - a	Standard alarm	Alarm output turns ON upon alarm condition, and alarm output turns OFF when condition is cleared.
RL - b	Alarm latch	Alarm output turns ON and maintains ON upon alarm condition.
RL - c	Standby sequence	The first alarm condition is ignored. It will operate as standard alarm from the second alarm condition. If it is under alarm condition when power is supplied, it will ignore the condition and operate as standard alarm from the next alarm condition.
RL - d	Alarm latch and standby sequence	It will operate as both alarm latch and standby sequence upon alarm condition. If it is under alarm condition when power is supplied, it will ignore the condition and operate as alarm latch from the next alarm condition.

3) Sensor break alarm

Alarm output turns ON when sensor is not connected or loses its connection during temperature control. Sensor disconnection can be tested by connecting buzzers or other devices to the alarm output contact. Sensor break alarm output operates through EV1 OUT or EV2 OUT contacts. Alarm output is disengaged after resetting the power.

4) Loop break Alarm (LBA)

Diagnose control loop and transmit alarm output through temperature change of control target. During heating(cooling) control, the alarm output turns ON if the PV does not rise/drop by a specific amount (approx. 2°C) during LBA monitoring period [L b R] while control output amount is at 100%(0%).

※If the thermal response of the control target is slow, the LBA monitoring period [L b R] of parameter group 1 should be set longer.

※LBA only operates when the control output amount is 100%(0%) so it cannot be used in current output models.

※If the alarm output turns ON after the sensor has been disconnected, the alarm output will not turn OFF even after reconnecting the sensor. To disengage the alarm output, the temperature controller power must be reset.

◎ Dual PID control

The response rate of the PID control can be selected depending on the characteristics of the control target. Select high-speed response mode or low-speed response mode [$P^i dF$, $P^i dS$] from PID method [$P^i dE$] of parameter group 2.

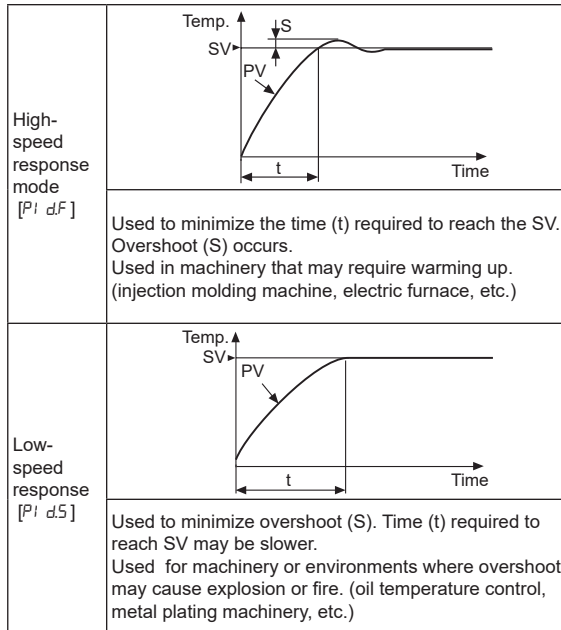

◎ Input correction [$i n - b$]

Used to correct deviation from external devices such as temperature controllers. E.g.) If the actual temperature is 80°C but the display value is 78°C, set the input correction [$i n - b$] value to 2 and it will display 80°C as the display value.

◎ Manual reset [$r E S E$]

When using proportional control (P control), the time of temperature rising time and falling time may differ depending on factors such as the heat capacity of the control device or the heater. A certain amount of deviation occurs even under stable conditions. This deviation is referred to as offset, and can be configured/corrected using manual reset [$r E S E$]. When PV and SV are equal, the reset value is 50.0%. If the PV is lower than the SV during stable control, set the value to over 50.0%, and if the PV is higher than the SV, set the value to under 50.0%

• Configuring manual reset [$r E S E$] according to control results.

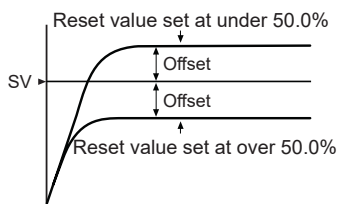

■ RS485 Communication

Applicable for models that support RS485 communication. Please refer to 'Ordering Information'. It is used to transmit PV or SV, and/or set the SV.

◎ Interface

Protocol	BCC
Applied standard	EIA RS485
Max. connections	31 units (address: 1 to 99)
Communication method	2-wire half duplex
Synchronization method	Asynchronous
Communication distance	Within 1.2km
Communication speed	2400, 4800, 9600bps
Start bit	1-bit fixed
Data bit	8-bit fixed
Parity bit	None
Stop bit	1-bit fixed

✗ It is not allowed to set overlapping communication address at the same communication line. Use twisted pair wire for RS485 communication.

◎ Application of system organization

✗ Only for RS485 communication output model.

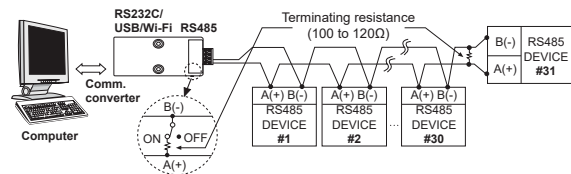

✗ It is recommended to use Autonics communication converter; SCM-WF48 (Wi-Fi to RS485-USB wireless communication converter, sold separately), SCM-US481 (USB to RS485 converter, sold separately), SCM-381 (RS232C to RS485 converter, sold separately). Please use twisted pair wire for RS485 communication.

◎ Communication control ordering

1. The communication control ordering of TZ/TZN Series is exclusive protocol.
2. After 4 sec being supplied the power into master system, then able to start communicating.
3. Initial communication will be started by master system. When Command signal comes out from master system then TZ/TZN Series will respond.

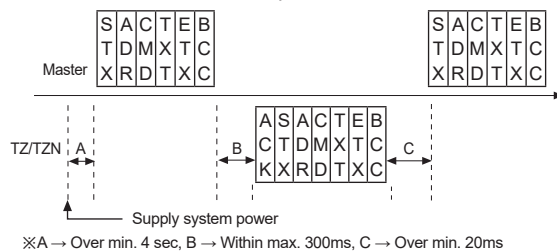

SENSORS
CONTROLLERS
MOTION DEVICES
SOFTWARE
(J) Temperature Controllers
(K) SSRs
(L) Power Controllers
(M) Counters
(N) Timers
(O) Digital Panel Meters
(P) Indicators
(Q) Converters
(R) Digital Display Units
(S) Sensor Controllers
(T) Switching Mode Power Supplies
(U) Recorders
(V) HMIs
(W) Panel PC
(X) Field Network Devices

TZN/TZ Series

③ Communication command and block

Format of command and response

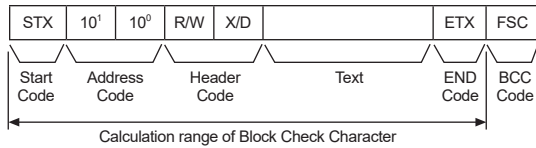

- ① Start code
It indicates the first of Block STX → [02H],
in case of response, ACK will be added.
- ② Address code
This code is master system can discern TZ/TZN Series
and able to set within range of 01 to 99. (BCD ASCII)
- ③ Header code
It indicates command as 2 alphabets as below.
RX (Read request) → R [52H], X [58H]
RD (Read response) → R [52H], D [44H]
WX (Write request) → W [57H], R [58H]
WD (Write response) → W [57H], D [44H]
- ④ Text: It indicates the detail contents of command/
response. (see command)
- ⑤ END code: It indicates the end of Block. ETX → [03H]
- ⑥ BCC: It indicates XOR operating value from the first to
ETX of the protocol as abbreviation of TZ/TZN.

③ Communication command

• Read [RX] of measurement/setting value: address 01, command RX

1.Command (master)

① Command

STX	0	1	R	X	P	0	ETX	FSC
Start	Address		Command head		P:Process value S:Setting value		End	BCC

② Application: address (01), header code (RX),
process value (P)

STX	0	1	R	X	P	0	ETX	FSC
02	30	31	52	58	50	30	03	BCC

• Write [WX] of setting value: address 01, command WX

1.Command (master)

① Command

STX	0	1	W	X	S	0	Symbol	10 ³	10 ²	10 ¹	10 ⁰	ETX	FSC
Start	Address		Command head		S:Setting value	Space/-	10 ³	10 ²	10 ¹	10 ⁰	End	BCC	

② Application: In case of writing address (01), heading
coad (WX), setting value (S) +123.

STX	0	1	W	X	S	0	Symbol	10 ³	10 ²	10 ¹	10 ⁰	ETX	FSC
02	30	31	57	58	53	30	20	30	31	32	33	03	BCC

③ Response

• Read of process/Setting value

1. In case of receiving normal process value:
The data is transmitted adding ACK [60H].
(In case process value is +123.4)

A C K	S T X	0	1	R	D	P	0	Symbol	10 ³	10 ²	10 ¹	10 ⁰	Decimal point	E T X	F S C	N U L L
-------------	-------------	---	---	---	---	---	---	--------	-----------------	-----------------	-----------------	-----------------	---------------	-------------	-------------	------------------

A C K	S T X	0	1	R	D	P	0	Space	1	2	3	4	1	E T X	B C C	N U L L
-------------	-------------	---	---	---	---	---	---	-------	---	---	---	---	---	-------------	-------------	------------------

06	02	30	31	52	44	50	30	20	31	32	33	34	31	03	B C C	00
----	----	----	----	----	----	----	----	----	----	----	----	----	----	----	-------------	----

2. In case process value is -100

A C K	S T X	0	1	R	D	P	0	-	0	1	0	0	0	E T X	B C C	N U L L
-------------	-------------	---	---	---	---	---	---	---	---	---	---	---	---	-------------	-------------	------------------

06	02	30	31	52	44	50	30	2D	30	31	30	30	30	03	B C C	00
----	----	----	----	----	----	----	----	----	----	----	----	----	----	----	-------------	----

※It is responded with 1 byte sized NULL (00H) at the end
of response frame (next BCC 16).

• Write of setting value

In case setting value is -100

A C K	S T X	0	1	W	D	S	0	Symbol	10 ³	10 ²	10 ¹	10 ⁰	E T X	F S C
-------------	-------------	---	---	---	---	---	---	--------	-----------------	-----------------	-----------------	-----------------	-------------	-------------

A C K	S T X	0	1	W	D	S	0	—	0	1	0	0	E T X	B C C
-------------	-------------	---	---	---	---	---	---	---	---	---	---	---	-------------	-------------

06	02	30	31	57	44	53	30	2D	30	31	30	30	03	B C C
----	----	----	----	----	----	----	----	----	----	----	----	----	----	-------------

• Others: In case of no response of ACK

- ① When the address is not the same after receiving STX.
- ② When receiving buffer overflow is occurred.
- ③ When the baud rate or others communication setting
value are not the same.

• When there are no ACK response

- ① Check the status of lines
- ② Check the communication condition (setting value)
- ③ When assuming the problem is due to noise, try to
operate communication 3 times more until recovery.
- ④ When occurred communication failure frequently,
please adjust the communicating speed.

■ Error Display

Display	Description	Troubleshooting
oPE n	Blinks when input is disconnected.	Check input status.
HHHH	Blinks when the measured input value is higher than the temperature range.	Adjust the value to within the temperature range.
LLLL	Blinks when the measured input value is lower than the temperature range.	

■ Proper Usage

◎ Troubleshooting

Symptoms	Troubleshooting
oPE n is displayed on the PV display during operation	Disconnect the power and check the input connection. If the input is connected, disconnect the input wiring from the temperature controller and short the + and - terminals. Power the temperature controller and check if it displays the room temperature. If it does not display the room temperature and continues to display oPE n, the controller is broken. Please contact our technical support. (Input type is thermocouple)
Load (heater, etc.) does not operate during operation	Check the state of the control output indicator on the front panel. If the indicator is not working, check parameter settings. If the indicator is working, disconnect the wiring from the output terminal of the temperature controller and check the output (reply contact, SSR drive, current).
Err (error) is displayed on the PV display during operation	Indicates damage to internal chip by strong noise (2kVAC). Please contact our technical support. Locate the source of the noise and devise countermeasures.

◎ Cautions during use

- Follow instructions in 'Cautions during Use'. Otherwise, It may cause unexpected accidents.
- Check the polarity of the terminals before wiring the temperature sensor.
For RTD temperature sensor, wire it as 3-wire type, using cables in same thickness and length.
For thermocouple (CT) temperature sensor, use the designated compensation wire for extending wire.
- Keep away from high voltage lines or power lines to prevent inductive noise.
In case installing power line and input signal line closely, use line filter or varistor at power line and shielded wire at input signal line.
Do not use near the equipment which generates strong magnetic force or high frequency noise.
- Install a power switch or circuit breaker in the easily accessible place for supplying or disconnecting the power.
- Do not use the unit for other purpose (e.g. voltmeter, ammeter), but temperature controller.
- When changing the input sensor, turn off the power first before changing.
After changing the input sensor, specify internal switch and modify the value of the corresponding parameter.
- Do not overlapping communication line and power line.
Use twisted pair wire for communication line and connect ferrite bead at each end of line to reduce the effect of external noise.
- Make a required space around the unit for radiation of heat.
For accurate temperature measurement, warm up the unit over 20 min after turning on the power.
- Make sure that power supply voltage reaches to the rated voltage within 2 sec after supplying power.
- Do not wire to terminals which are not used.
- This unit may be used in the following environments.
 - ① Indoors (in the environment condition rated in 'Specifications')
 - ② Altitude max. 2,000m
 - ③ Pollution degree 2
 - ④ Installation category II

SENSORS

CONTROLLERS

MOTION DEVICES

SOFTWARE

(J) Temperature Controllers

(K) SSRs

(L) Power Controllers

(M) Counters

(N) Timers

(O) Digital Panel Meters

(P) Indicators

(Q) Converters

(R) Digital Display Units

(S) Sensor Controllers

(T) Switching Mode Power Supplies

(U) Recorders

(V) HMIs

(W) Panel PC

(X) Field Network Devices